

DOCUMENT RESUME

ED 431 617

SE 062 628

TITLE International Space Station: K-5 Hands-on Science and Math Lesson Plans.

INSTITUTION Boeing Co., Huntsville, AL.

PUB DATE 1999-00-00

NOTE 64p.

AVAILABLE FROM Boeing, P.O. Box 240002, Huntsville, AL 35824.

PUB TYPE Guides - Classroom - Learner (051)

EDRS PRICE MF01/PC03 Plus Postage.

DESCRIPTORS \*Aerospace Technology; Astronomy; Elementary Education; \*Mathematics Activities; Mathematics Education; \*Science Activities; Science Education; Scientific Research; Space Exploration; \*Space Sciences

IDENTIFIERS \*Space Stations

ABSTRACT

The Space Station is already capturing the imaginations of American students, encouraging them to pursue careers in the sciences. The idea of living and working in space continues to spark this renewed interest. The material in this guide was developed to provide hands-on experiences in science and math in the context of an International Space Station. The lesson plans are written to be used with K-5 students in groups of two to four people in a lab-type activity. The contents of this guide include: (1) an introduction to the National Aeronautics and Space Administration (NASA) and the United States Space Station Program; (2) a diagram of the Space Station configuration; (3) Space Station Identification (Lesson 1); (4) Space Station Habitat and Laboratory (Lesson 2); (5) Outfitted for Space Work (Lesson 3); (6) Water Conservation on Space Station (Lesson 4); (7) Space Station Math (Lesson 5); and (8) an answer booklet. (WRM)

\*\*\*\*\*  
 \* Reproductions supplied by EDRS are the best that can be made \*  
 \* from the original document. \*  
 \*\*\*\*\*

# International Space Station

## K-5 Hands-On Science and Math Lesson Plans

PERMISSION TO REPRODUCE AND DISSEMINATE THIS MATERIAL HAS BEEN GRANTED BY

*L. Slater*

TO THE EDUCATIONAL RESOURCES INFORMATION CENTER (ERIC)

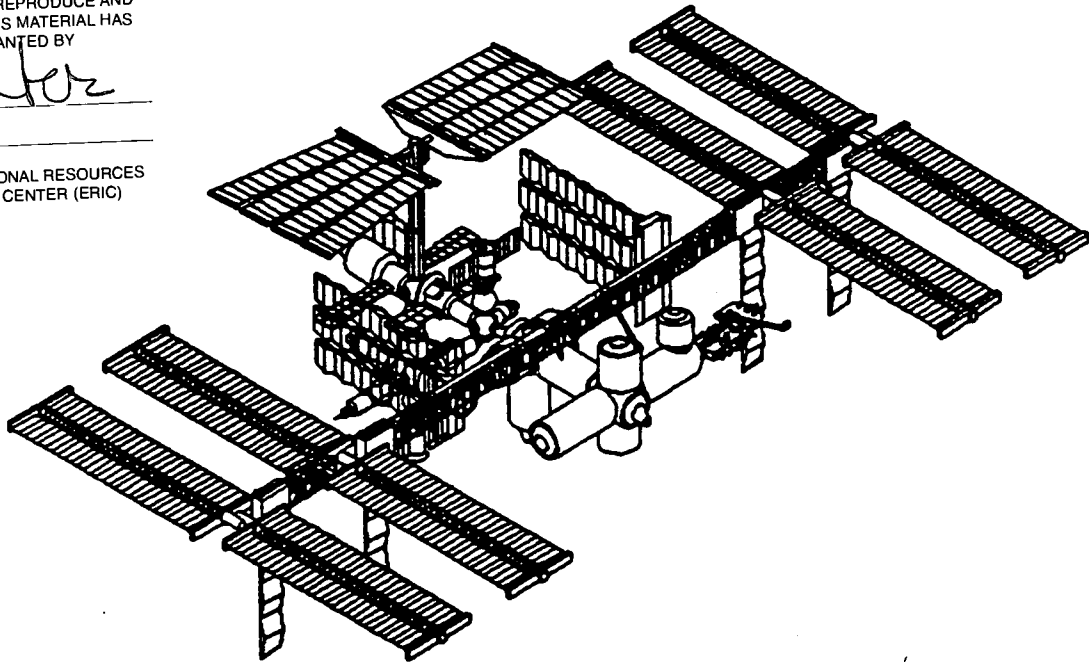

U.S. DEPARTMENT OF EDUCATION  
Office of Educational Research and Improvement  
EDUCATIONAL RESOURCES INFORMATION  
CENTER (ERIC)

This document has been reproduced as received from the person or organization originating it.

Minor changes have been made to improve reproduction quality.

• Points of view or opinions stated in this document do not necessarily represent official OERI position or policy.

BEST COPY AVAILABLE

# Space Station

Level (Grades K-5)

---

Dear Teacher:

This material has been developed to provide a guide to hands-on experiences in science and math. The lesson plans are written to be used by the students in groups of two to four people in a lab-type activity. The lesson activities are outlined using the scientific method. All questions should be used to lead the students to explore a subject, and the activities should be open ended.

Each lab session should begin with a brief discussion of the Theory/Information section of the lesson plan. The teacher should feel free to adjust the information and activities to meet the needs of the students. For the very young, the teacher may lead the activity and adapt the questions.

These plans are intended to be used by students. The teacher will actively participate by moving among the students to help each group to organize, supply materials, provide information, and answer questions.

The space station is already capturing the imaginations of American students, encouraging them to pursue a career in the sciences. The idea of living and working in space continues to spark this renewed interest. It is with this desire that we dedicate this educational work to encouraging our children to pursue their dreams. The space station will motivate, stimulate, and capture our children's imagination as only space exploration can.

Space Station Partners  
for Educational Advancement

# Introduction

Level (Grades K-5)

---

## Introduction to the National Aeronautics and Space Administration (NASA) and the United States Space Station Program.

The National Aeronautics and Space Administration (NASA) is an independent federal agency with headquarters in Washington, D.C. This federal agency does nonmilitary research into problems of flight within and beyond Earth's atmosphere. In 1958 the Space Act Agreement established the National Aeronautics and Space Administration. Since that time NASA has experimented with rockets, unmanned probes and satellites, and manned missions including the Apollo moon missions, and the Space Shuttle flights.

The United States Space Station Program is also under the direction of the National Aeronautics and Space Administration. After the first Space Shuttle flew in April of 1981, a space station was considered to be the next logical step in human space flight. In May 1982, the Space Station Task Force was formed and produced a space station concept.

In 1984 after many studies, President Reagan committed the nation to the goal of developing a space station with permanent human occupancy within the decade. At that time he also stressed international participation, and NASA invited other countries to work with the United States to develop a space station. Finally in September of 1988, Japan, Canada and 9 of the 13 nations involved with the European Space Agency (ESA) agreed to work together on the Space Station Program. The nine European Space Agency members are Belgium, Denmark, France, Italy, the Federal Republic of Germany, the Netherlands, Norway, Spain and the United Kingdom.

In 1992, President Clinton asked NASA to redesign the station to lower the cost. NASA, with the help of aerospace contractors such as The Boeing Company, began working on the redesign. During the planning, it was decided that members of the Russian Space Agency would help with the new space station.

The Human Tended Capability, the first phase of space station, will be completed in 1998 after the Assembly Flights. This first phase includes the laboratory module. The final phase, Permanent Human Capacity, is scheduled for 2003. The station is designed to operate for at least 10 years.

# Introduction (Continued):

Level (Grades K-5)

---

## Introduction to the National Aeronautics and Space Administration (NASA) and the United States Space Station Program.

The space station will support six crew members. The crew will serve for 90 days, and then they will be replaced by another crew of six. The crew will be rotated four times each year. Crew members involved in long-duration microgravity studies may serve six months or more before they return to Earth.

The space station will travel at a speed of about 29,000 kilometers per hour (18,000 miles per hour), and it will complete one orbit every 90 minutes. The station will operate at an altitude of 335 to 460 kilometers (208 to 285 statute miles). This is about the distance from New York to Washington, D.C.

The space station will be a permanent Earth orbiting laboratory. By observing and collecting information from the space station, scientists will learn more about our home planet, Earth. By collecting information, conducting experiments, and manufacturing materials on orbit, they will develop new processes and technologies. The biological studies done on orbit also hold great promise for the development of new medicines and the understanding of various diseases such as anemia and osteoporosis.

A space station is also needed to help humans to continue to explore space. The station will encourage international cooperation in science and technology while enabling scientists to perform significant long-duration space research in materials and life sciences. While building the station, scientist and engineers will also learn more about building, maintaining, and operating advanced human and autonomous space systems.

The space station will allow scientists more time to study and experiment in very low gravity, more power for equipment, and more room to work.

# Space Station Configuration

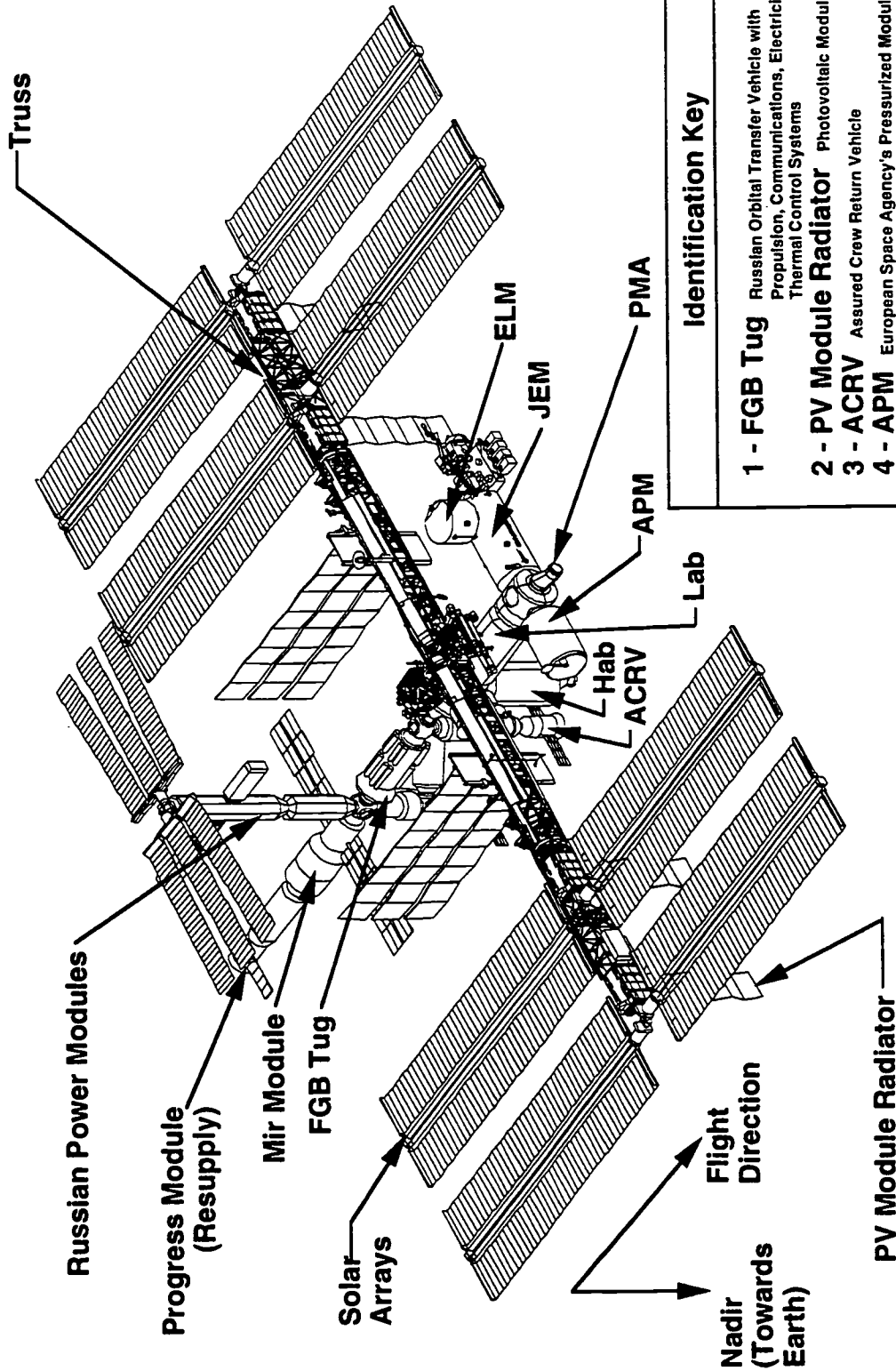

Identification Key	
1 - FGB Tug	Russian Orbital Transfer Vehicle with Propulsion, Communications, Electricity, and Thermal Control Systems
2 - PV Module Radiator	Photovoltaic Module Radiator
3 - ACRV	Assured Crew Return Vehicle
4 - APM	European Space Agency's Pressurized Module
5 - Hab	Habitat Module
6 - Lab	Laboratory Module
7 - PMA	Pressurized Mating Adaptor
8 - ELM	Experimental Logistics Module
9 - JEM	Japanese Experimental Module
10 - Mir	Russian Module

# Table of Contents

Level (Grades K-5)

---

Letter to Teacher	i
Introduction: Introduction to the National Aeronautics and Space Administration and the United States Space Station Program.	ii
Space Station Configuration	iv
Lesson 1: Space Station Identification	1
Lesson 2: Space Station Habitat and Laboratory	7
Lesson 3: Outfitted for Space Work	27
Lesson 4: Water Conservation on Space Station	41
Lesson 5: Space Station Math	47
Answer Booklet	49

# Space Station Identification





Level (Grades K-5)

## THEORY/INFORMATION

The space station is a large human-tended spaceship that will orbit 335-460 kilometers (208-285 statute miles) above the Earth. This station is to be used as a permanent laboratory where astronauts live and work. A crew of six will work 90 days, and then another group will come to the station. The first crew will return to Earth. NASA plans four trips each year. The first phase of the space station will be placed in orbit in 1998, and the whole station should be in place and operating in 2003. (See drawing page iv.)

Some of the most important parts of the space station are the **truss**, **photovoltaic arrays**, **laboratory modules**, **nodes**, **habitat module** and **radiators**.

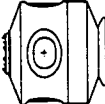
A description of these six parts follows:

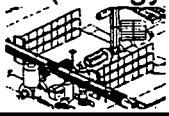
- A. A **truss** (trus) is a backbone-like metal structure located on the outside of the station. The **truss** is used to support and connect other parts of the space station.
- 
- B. The **photovoltaic arrays** (pho•to•vol•ta•ic ar•ray ) are sets of solar panels grouped together in big sheets. These arrays collect light from the Sun and use it to make electricity to power the equipment and machines on the space station.
- 
- C. The **laboratory modules** (lab•o•ra•to•ry mod•ules) are filled with most of the equipment used for studying processes, manufacturing materials, and doing experiments. Every day the astronauts will work in these modules.
- 
- D. **Nodes** (nodes) attach one module to another, and they are used as passageways so that the astronauts can go from one module to another. The **nodes** are also used for some experiments and for storage.
- 
- E. The astronauts will live in the **habitat module** (habi•tat mod•ule). They will cook, eat, clean, sleep, bathe, exercise, and relax in this module.
- 
- F. A **radiator** (ra•di•a•tor) removes heat from the space station. Energy in the form of electricity from the photovoltaic arrays is used to perform work in space station. This same energy is converted to heat during this work and must be removed or the space station will become too hot to live in. (Energy in = energy out is an important and fundamental science concept).
- 



## OBJECTIVE

The student will identify five major parts of the space station. He/she will match each of these parts with the function.

## QUESTIONS

What are five major parts of the space station? What does each part do?

## MATERIALS

- 1 Labeled drawing of the space station
- 1 Space Station Vocabulary Match Worksheet
- 1 Pair of scissors
- 1 Pencil
- Crayons (orange, yellow, green, blue, red)
- Glue

## PROCEDURES

1. Observe and discuss the labeled drawing of the space station. (See page 3.)
2. Find the Space Station Vocabulary Match Worksheet.
3. Use your scissors to cut out the definitions located at the bottom of the Space Station Match Worksheet.
4. Glue each definition beside the correct word.
5. Use your **crayons** and **color** the parts of the space station.

**Truss** - orange

**Laboratory Module** - red

**Solar Arrays** - yellow

**Nodes** - green

**Habitat Module** - blue

# Space Station

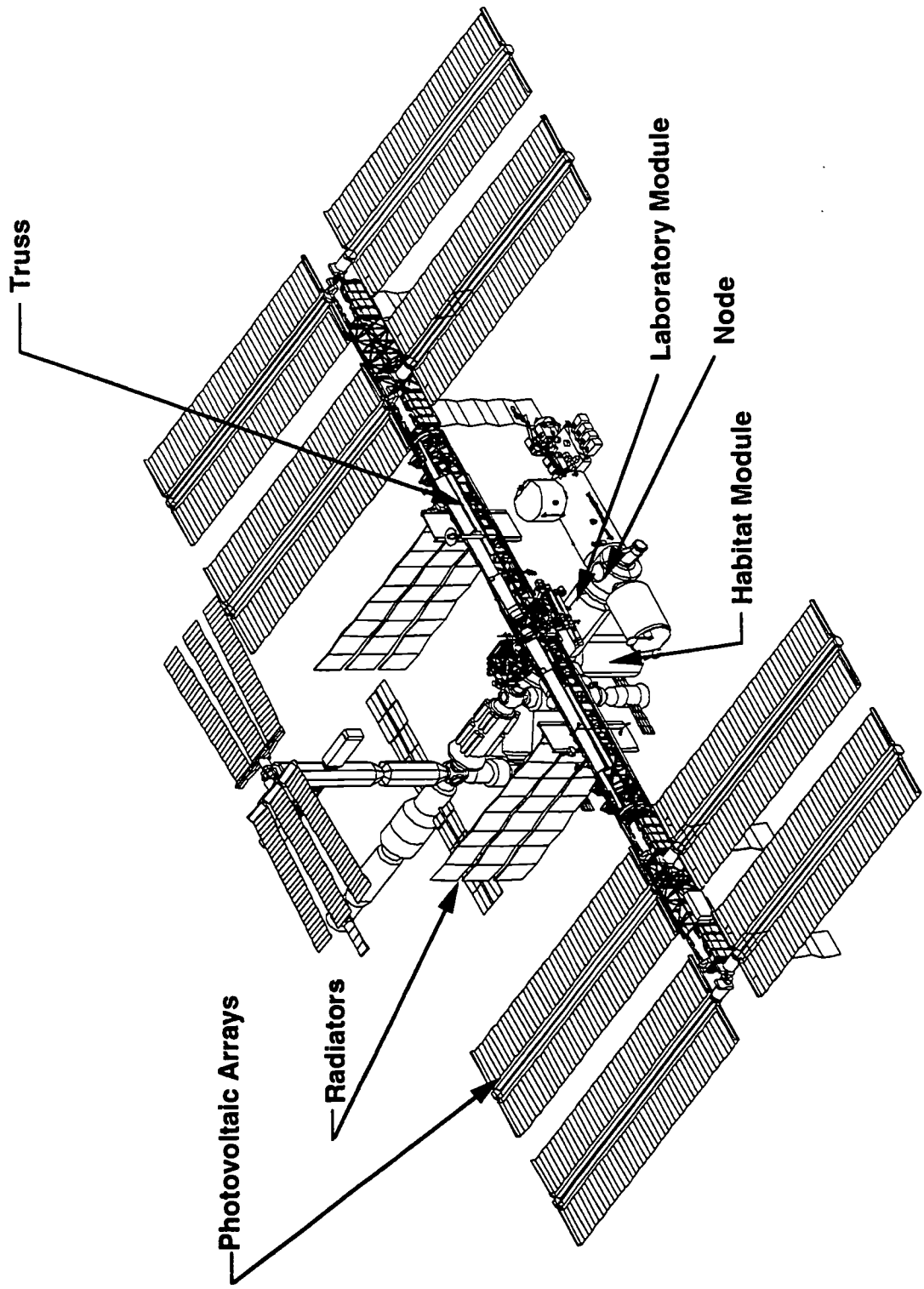

# OBSERVATIONS, DATA and CONCLUSIONS

1. What parts of the space station will make electric power to run the machines?
2. What two parts of the space station are used to hold some of the other parts of the station together?
3. Where will the astronauts work?
4. Where will the astronauts live?
5. If you were planning the space station, which part of the station would you put into orbit first? Why?

# Space Station Vocabulary Match

1. Node -
2. Habitat Module -
3. Truss -
4. Photovoltaic Array -
5. Laboratory Module -
6. Radiators

Definitions: (Cut along the dotted lines and glue them into place)

A. The part of the space station that makes electricity to run the machines and equipment

B. The backbone-like support used to attach many parts of the space station together.

C. The place where the astronauts will eat, sleep, clean, bathe, cook, exercise, and relax.

D. A part of the space station that serves as a passageway from one module to another.

E. The space station crew will spend 8-12 hours each day working here.

F. Removes heat from the space station so it will not be too hot to live in.

# Space Station Habitat and Laboratory Modules

Level (Grades K-5)

---

## THEORY/INFORMATION

The space station is a manned spaceship for humans to be used for exploring, studying, manufacturing, and experimenting while on orbit around the Earth. The station is a very complicated machine and it has many parts. Each part of the station is needed to support life or provide an environment for manufacturing and science activities.

Two very important parts of the station are the habitat and laboratory modules. Both modules are made so that racks can be taken out and moved or replaced. Racks are refrigerator-size reinforced cabinets used for storage or to attach equipment. The racks used in the U.S. Space Program are all the same size, 203.2 x 106.68 x 76.2 centimeters (80 x 42 x 30 inches). Each rack has a flat front surface, but the back is curved to fit into the cylinder-shape of the habitat and laboratory modules. There is a small space between the back of each rack and the circular outside wall of each module. This empty area is used to run the electric cables and fluid lines needed to operate the equipment attached to the racks. (See illustration on page 8.)

On orbit in the space station, there is no "up" or "down" because everything is weightless and floats. In order to work with each other and communicate with the scientists on Earth, the astronauts need a way to think and talk about "up" or "down" so the habitat and laboratory modules are designed to look like rooms on Earth. When not in use the inside of both the modules is a long box shaped area with four flat wall-like surfaces. The line of racks in two of the surfaces are marked to look like walls. Other racks are stored in areas made to look like the floor and ceiling. Lights and air vents are arranged around the top or ceiling. More return air vents are arranged around the floor of the modules. The walls of the modules are pale gray, and the handles are navy. The circular ends of the laboratory module are trimmed in royal blue, and the ends of the habitat module are trimmed in burgundy. The colors are used to mark the exits.

After the space station crew arrives, the supplies and equipment are unpacked from the racks, and then the modules are ready to use for working and living. The racks in the laboratory module will be changed when they are empty or when a manufacturing or science activity is finished. Some of the racks in the habitat module will be changed but others may only be cleaned and resupplied.

During the regular 90-day tour of duty, the crew of the space station will live in the habitat module. Scientists and engineers plan for the astronauts to cook, eat, wash dishes, clean, sleep, bathe, exercise, and relax in this module. The cooking and eating area is the galley. The racks in the galley have an oven and a way to dispose of trash.

Farther along the wall opposite the eating area is a restroom with a toilet and beside it is a shower. Other racks hold the clothing and dishes. To sleep, the astronauts attach their sleeping restraints to hooks on the front of the racks so they will not float around while they sleep.

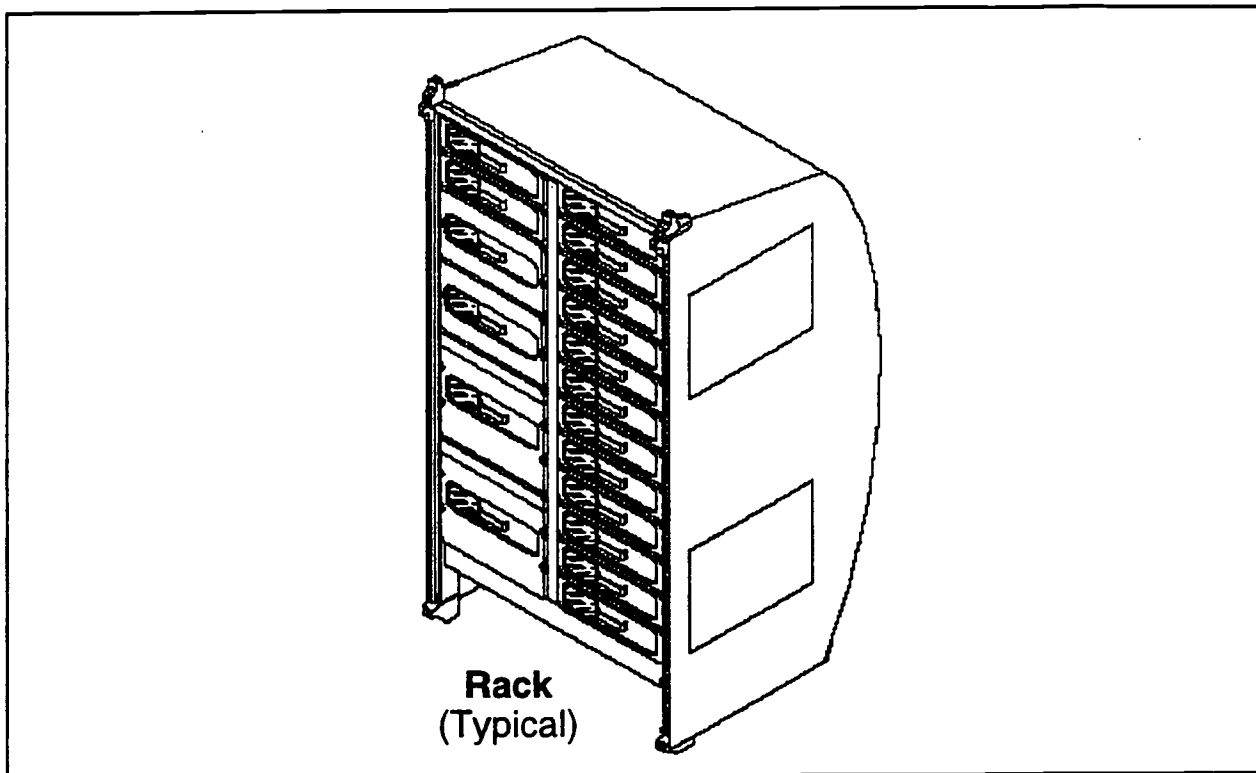

## OBJECTIVE

The student will assemble a model of the habitat module of the space station. The student will also plan and assemble his/her own laboratory module.

## QUESTIONS

What does the habitat module look like? Where are all the racks located? How would you arrange your own laboratory module?

## MATERIALS

- 1 Space station habitat module paper model. (8 sheets)
- 1 Pair of sharp scissors
- Crayons
- 1 Set laboratory module rack drawings
- 1 Bottle of rubber cement, glue, or transparent tape.  
(Hint: It is best to use rubber cement.)

# PROCEDURES

## Procedure A: Assemble the Habitat Module Model

1. Color the interior of the space station. Use the color key on the drawings of the habitat and laboratory modules.
2. After coloring, cut out each part of the space station habitat module model.
3. Fold the parts of the model and glue them together. (Hint: It is best to use rubber cement.) Follow the instructions on each part of the model.
4. Fold the display stand for the habitat module. Tape or glue the tabs into place.

## Procedure B: Assemble Your Own Laboratory Module. (Optional)

1. Plan your own laboratory module.
2. Color the laboratory racks.
3. Use your scissors and cut out the racks.
4. Put a small amount of rubber cement on the back of the paper rack.
5. Follow your own laboratory module plan. Glue the fronts of the laboratory racks over those on the model of the habitat module.

## OBSERVATIONS, DATA AND CONCLUSIONS

1. Observe the habitat and laboratory modules. What is the shape of the outside of these modules?
  
2. What is the shape of the inside of the two modules?

3. Count the racks in the habitat module model. How many racks are in this paper model? Do you think there are more racks in the real space station habitat module?
4. Where is the galley located?
5. Where are the toilet and shower?
6. As you probably noticed, there is no furniture in the habitat module. If pieces of furniture were sent to the space station and placed in the habitat module, what would happen to them?
7. The astronauts will sleep in the habitat module. There are no beds. Where will they sleep during the 90 days that they will be on the space station?
8. If you are an astronaut on the space station, you will work in the laboratory module 8-12 hours each day. You will sleep 8 hours each day in the habitat module and exercise 2 hours. How will you spend the two hours of free time each day?
9. (Optional) After you have planned and completed your own laboratory module, explain your plan.



# Space Station Habitat Module (Right Side)

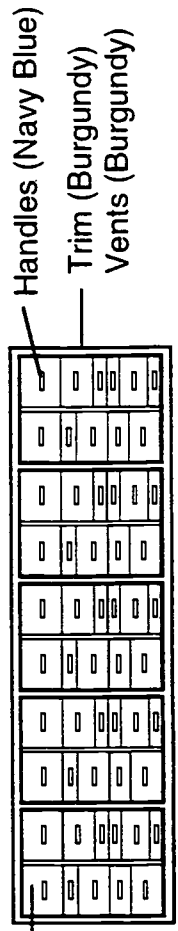
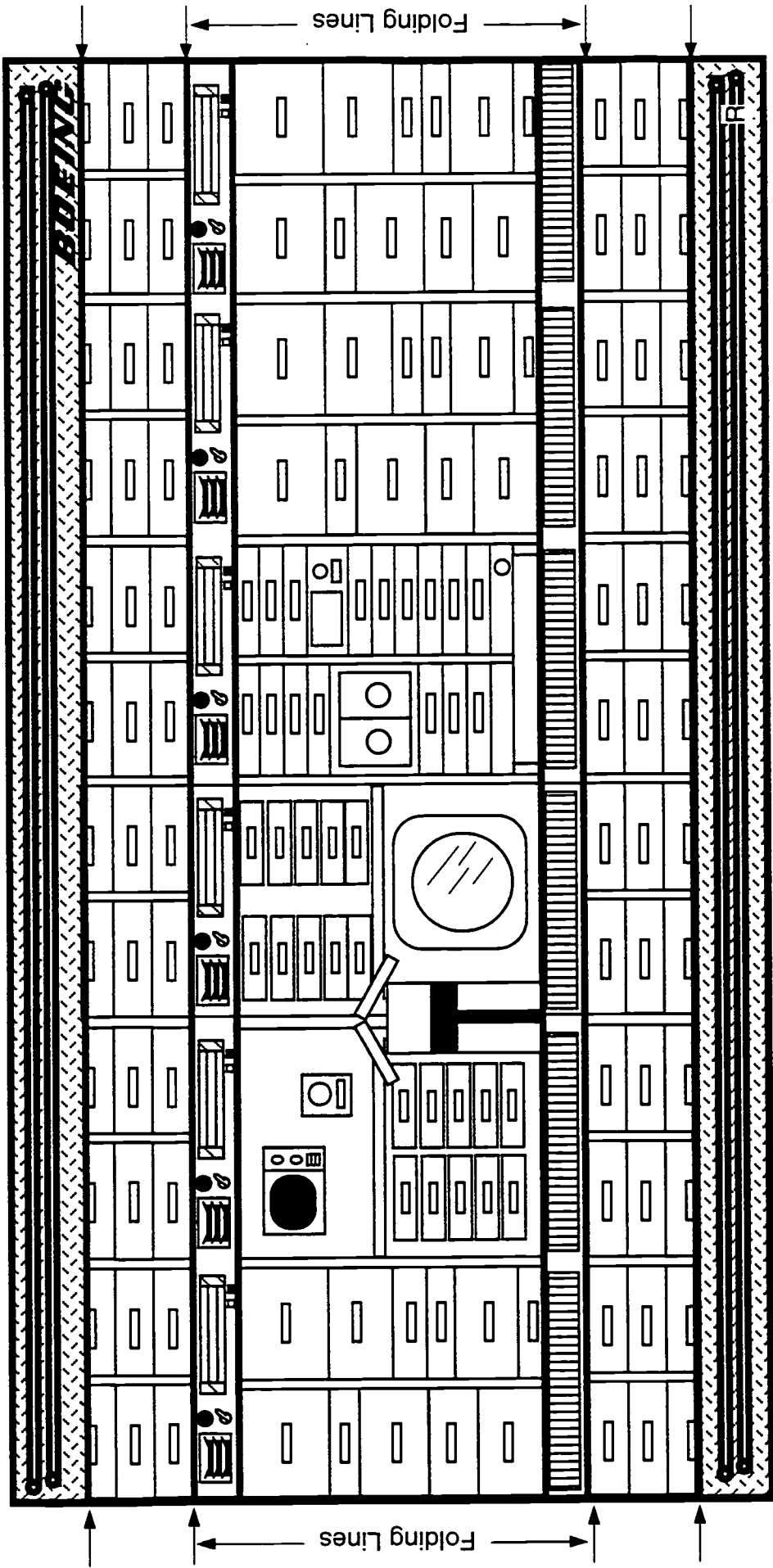

Color Key for Hab

# Space Station Habitat Module (Left Side)

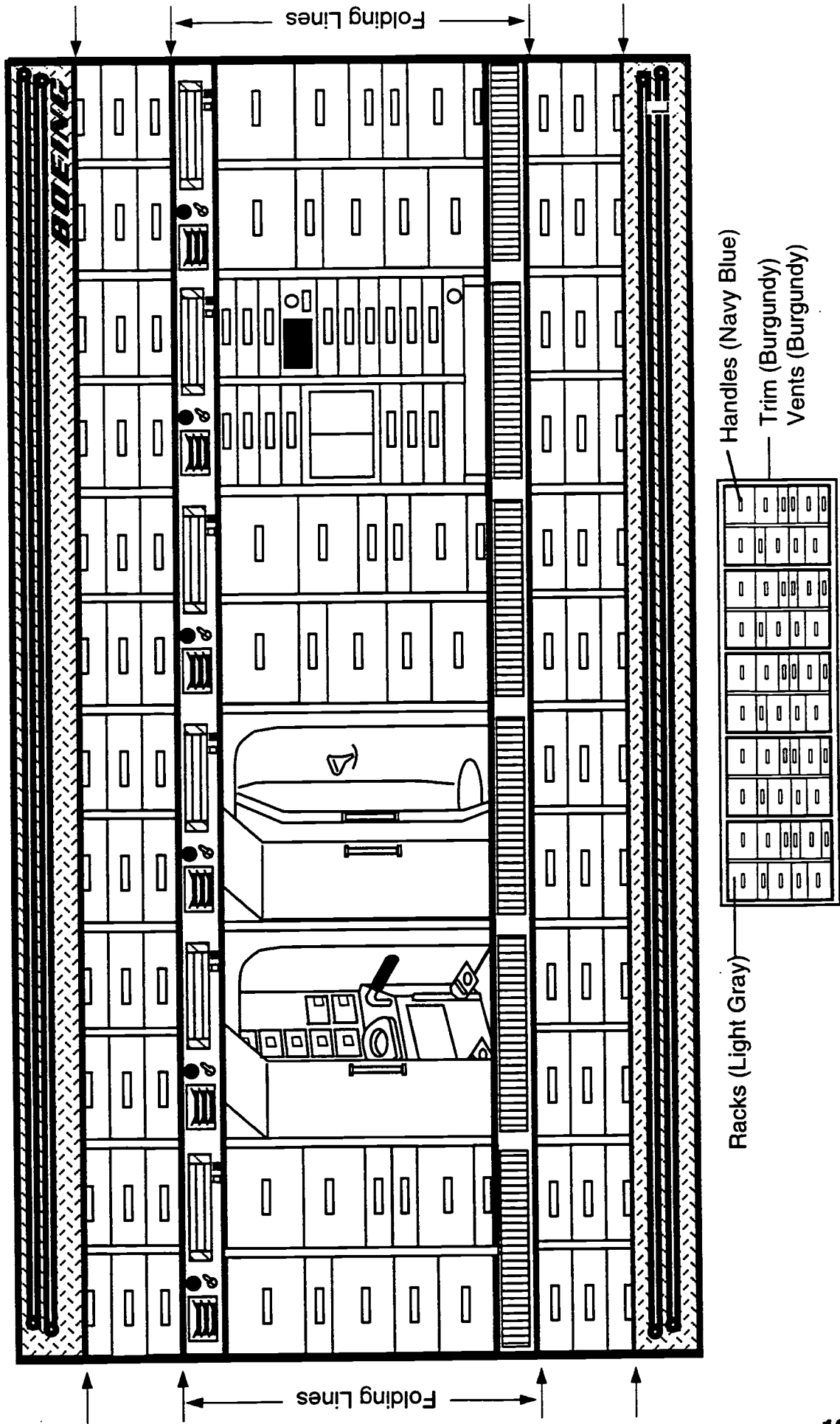

# Hab (Left Side)

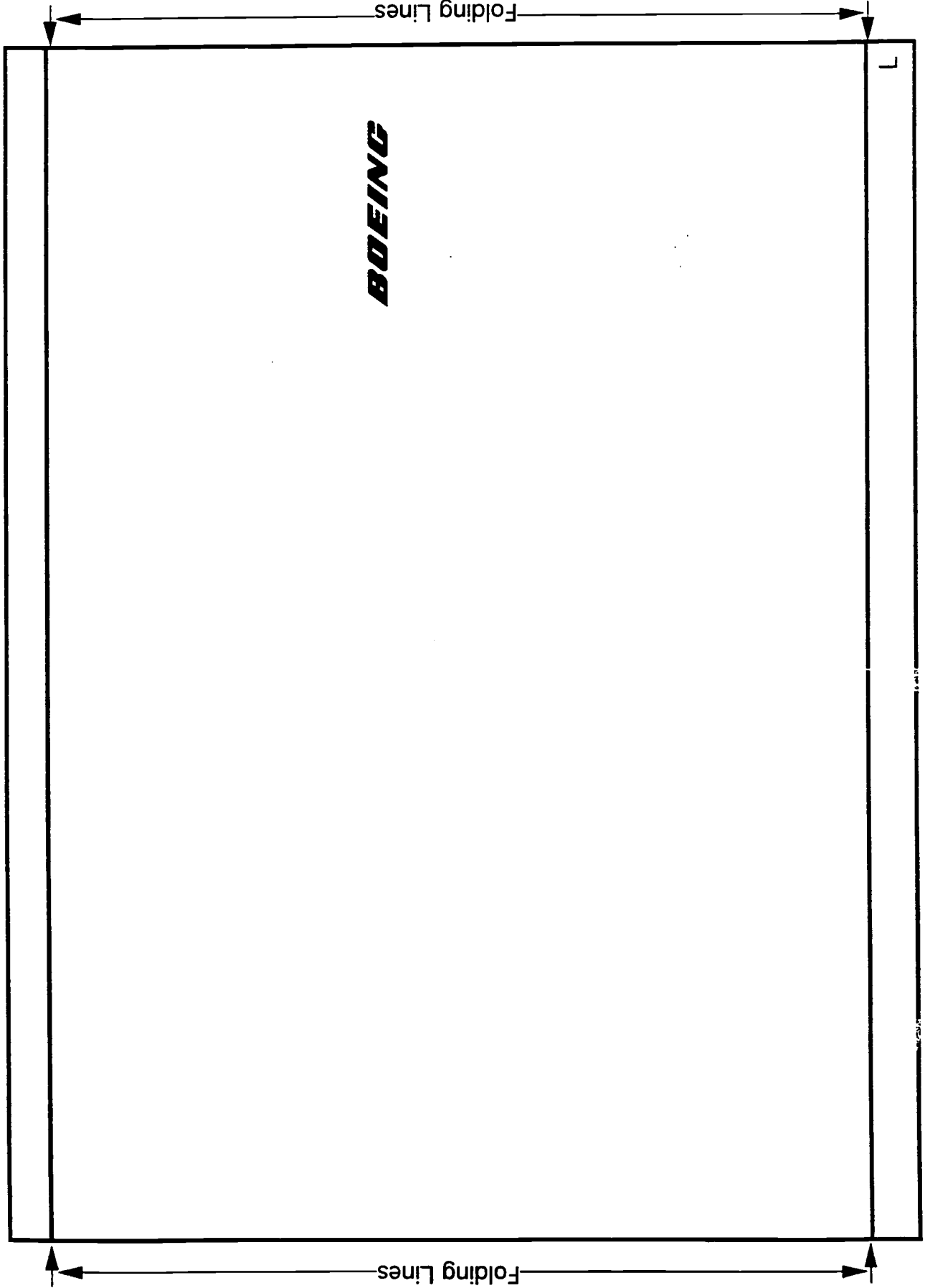

# Hab (Right Side)

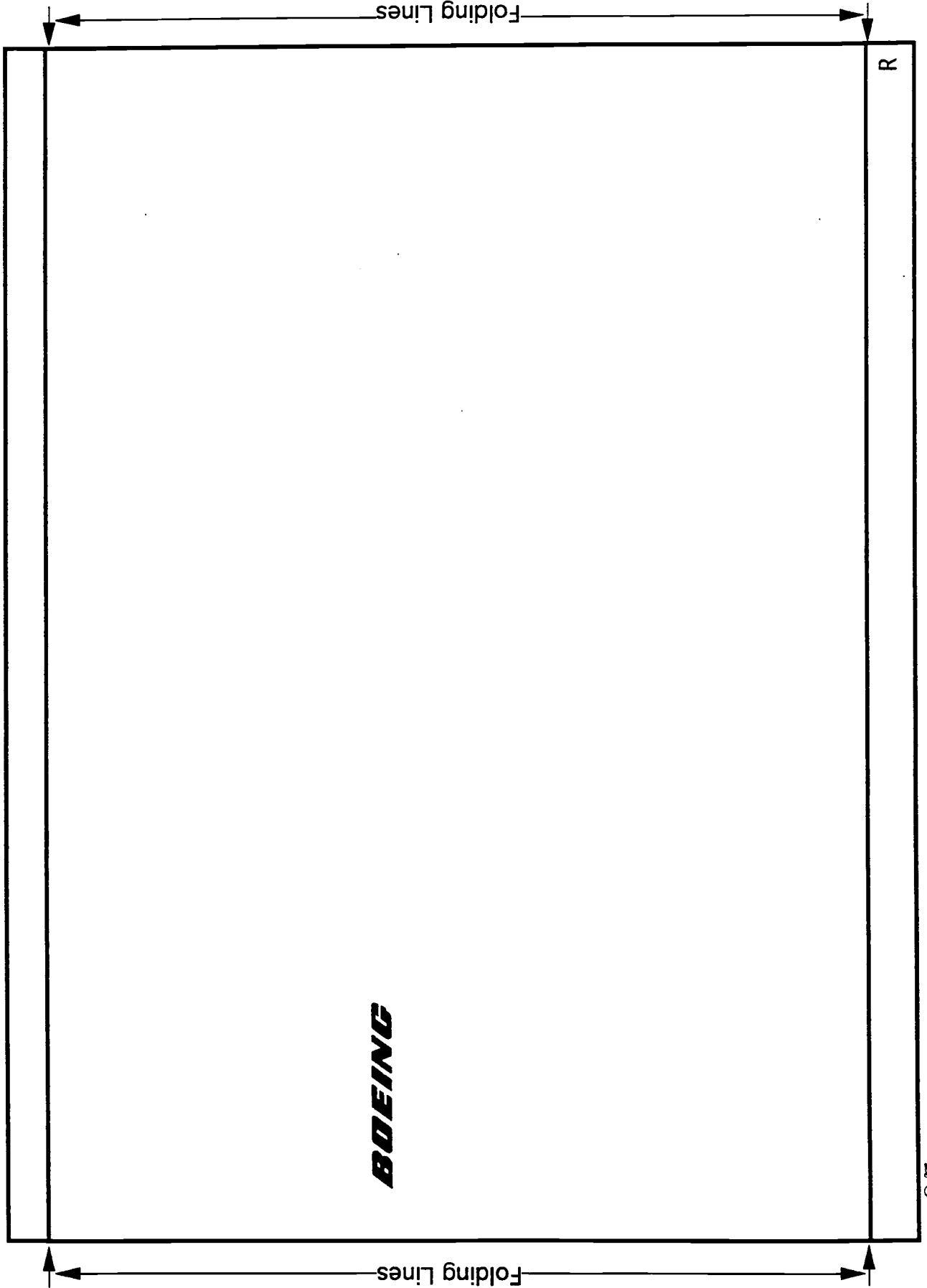

# Laboratory Module Rack Fronts

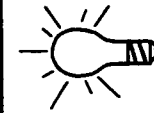
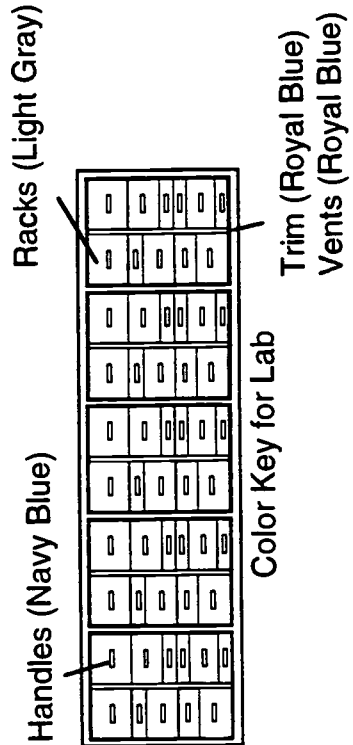
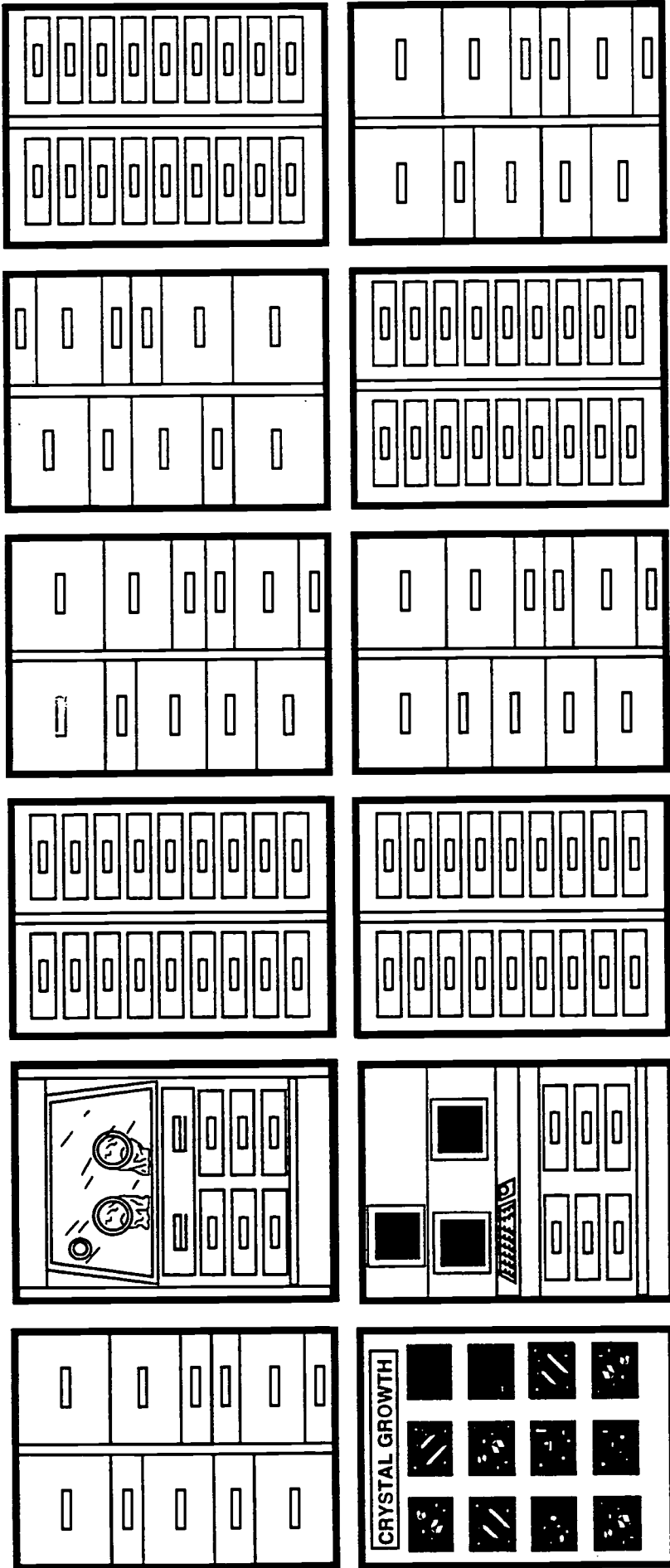

**Optional Idea:** A full size space station model. Place the rack front drawings in an opaque projector or make a viewgraph and place it on a projector. Project the rack illustrations onto bulletin board paper and copy the enlarged racks. Attach these paper rack fronts to large, cardboard refrigerator boxes and assemble a full size space station module. You may draw other racks on large white plastic and place one on the floor and drape another over the top of the boxes.

# Module Stands

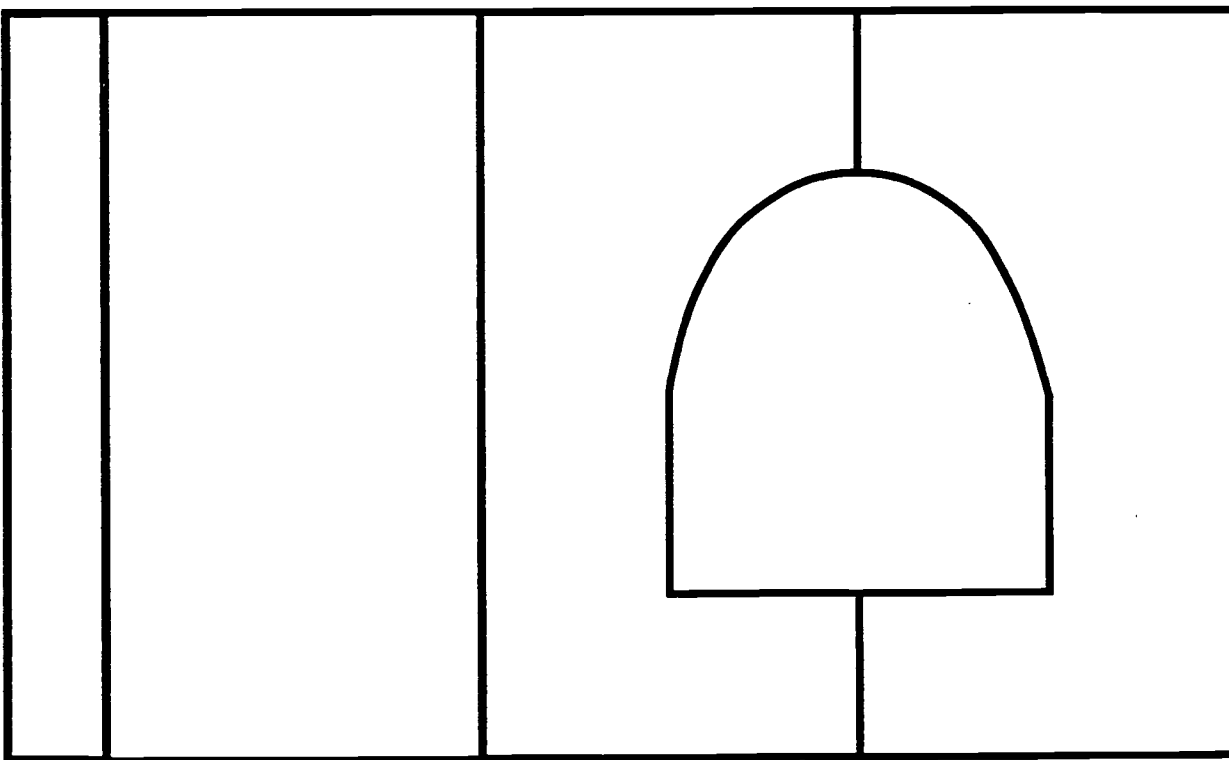

29

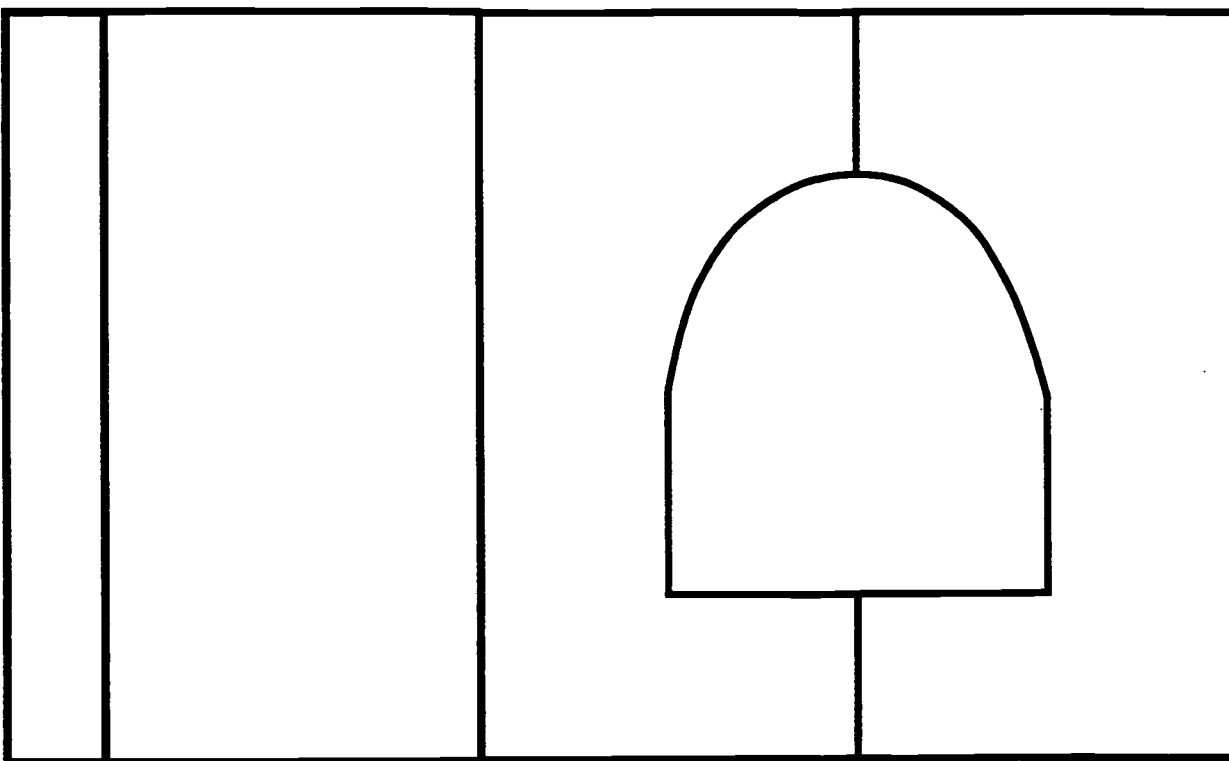

30

# Module Stands

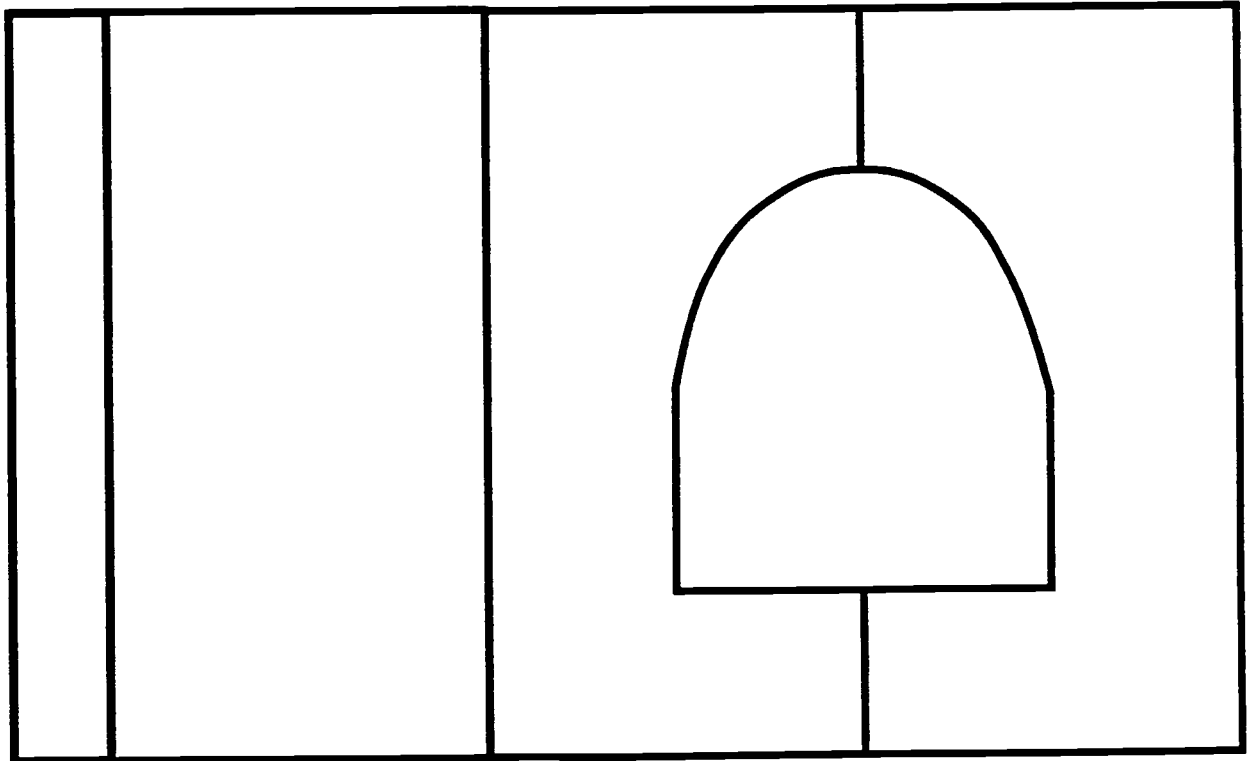

31

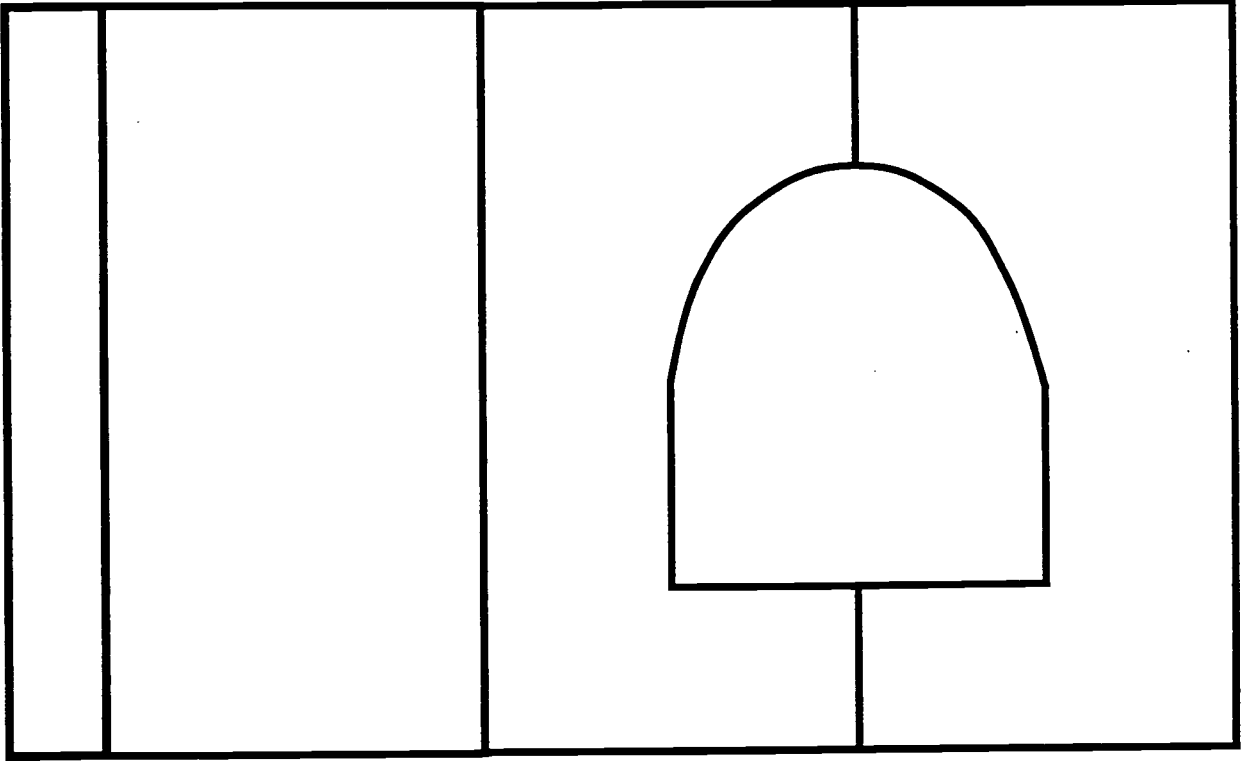

32

# Habitat Module Folding Instructions

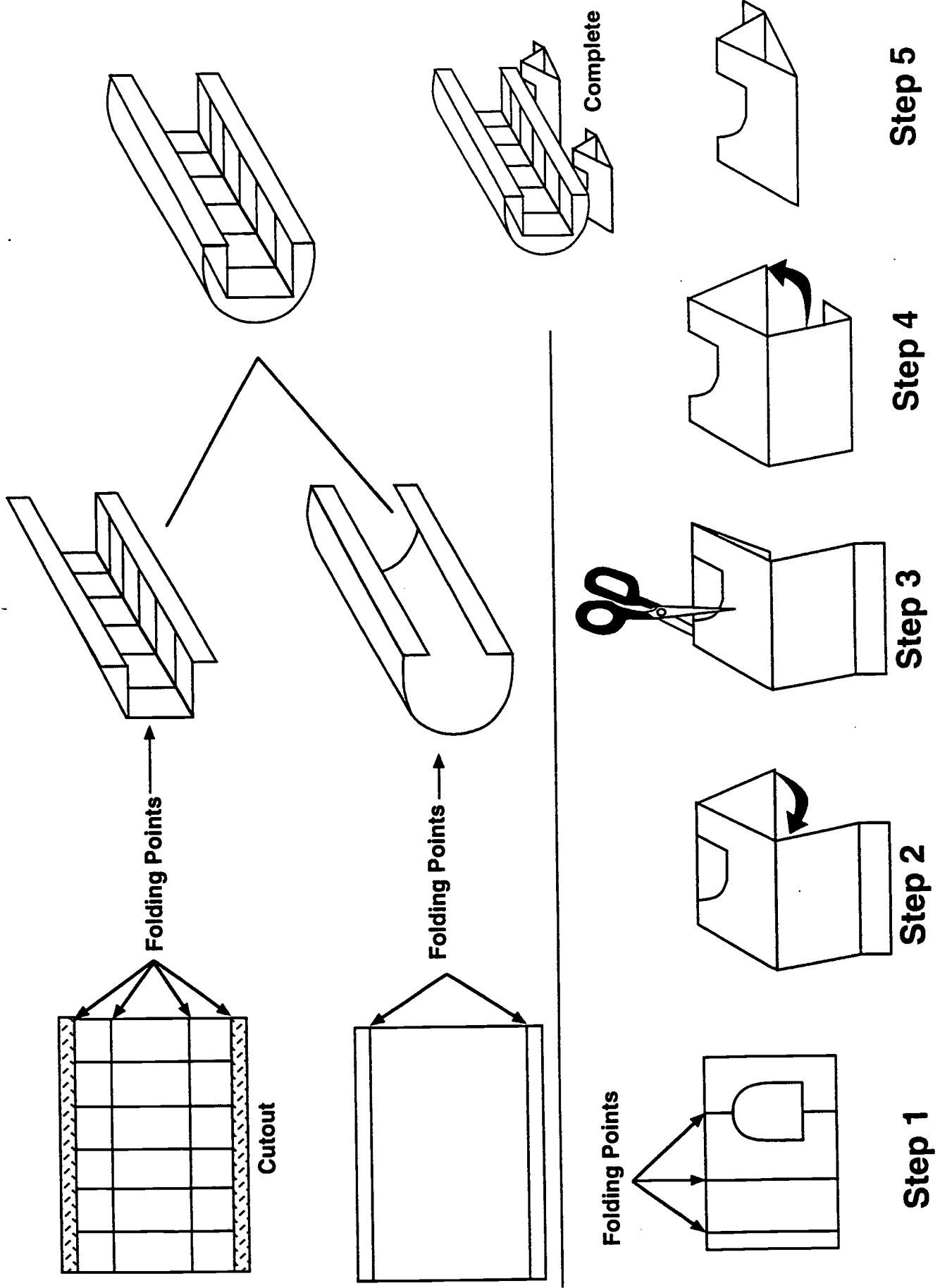



# Outfitted for Space Work

Level (Grades K-5)

---

## THEORY/INFORMATION

While on orbit in the space station, astronauts dress to live comfortably and work safely in the environment of space. Inside the station, the temperature is between 18.3 and 32.2 degrees Celsius (65 and 90 degrees Fahrenheit) with a relative humidity between 30 and 50 percent. Outside the station, temperatures vary from -100 Celsius to 120 degrees Celsius (-148 to 248 degrees Fahrenheit).

Each astronaut is outfitted with the clothing needed for the work that is to be done during his/her 90-day mission. All the crew members have clothing for cooking, cleaning, relaxing, and sleeping inside the space station. The astronauts that work in the laboratory module with manufacturing, experiments, or science activities, have the clothing needed for that job, too. They also have safety goggles and rubber or fire retardant gloves. Most of the time, the crew wears slipper socks, but they also have tennis shoes and boots.

Some of the crew members must work outside the space station, and they have clothing to protect themselves. The complicated space suit worn outside the space station is called an extravehicular mobility unit (EMU). This suit provides correct air pressure, temperature, oxygen, drinking water, food, and electrical power. It also protects the astronauts from micrometeoroids.

Astronauts aboard the space station will use improved EMU space suits when they go outside to build, repair, and resupply the station; check experiments; or fix satellites. The suits have many layers of materials, and it is very difficult to work while wearing them. Outside the station on an extravehicular activity (EVA), the crew member must wear the EMU and MMU (manned maneuvering unit) equipment which weighs 148 kilograms (about 326 pounds). On Earth, the space suit (EMU) alone weighs 113 kilograms (about 250 pounds). To practice on Earth, the astronauts work in a huge tank of water called a neutral buoyancy simulator. This simulator helps the astronaut learn to work while wearing the stiff, bulky suit. Scientists can float the astronaut and the equipment so that they can practice the tasks they will do when they are working aboard the space station.

After 90 days, the space station crew will prepare for the arrival of the new crew. Each astronaut will complete his/her chores, pack up, and get ready to go home. They will put on their flight coveralls for the return trip to planet Earth.

## OBJECTIVE

The student will choose an astronaut and dress him/her for the work to be done.

## QUESTIONS

What clothing is worn by astronauts while they are aboard the space station? What clothing is needed for each activity?

## MATERIALS

- 1 Set of paper dolls with the space station wardrobes
- 1 Pair of sharp scissors

## PROCEDURES

1. An astronaut is going outside the space station to repair a satellite. Find the astronaut and the clothes he/she will need.
2. Cut out each piece of clothing and equipment. Now dress the astronaut.
3. One astronaut has time off from work, and he is going to look out the window and take photographs. Dress this astronaut.
4. One astronaut will be working in the laboratory. This astronaut will check the crystal growing experiments. What will he/she wear? Dress this person for work.
5. It is the last day of the 90-day tour of duty. One astronaut is getting ready to return to Earth. What will this person wear? Dress this astronaut.
6. Display each astronaut on the stand provided.
7. (Optional) Students may wish to color the clothing provided for each astronaut. The space suit and the underwear is white. Space clothing is usually white, light blue, or navy but students may select their own colors.

# OBSERVATIONS, DATA AND CONCLUSIONS

1. List the clothing worn by the astronaut who works in the laboratory module.
2. List the clothing that astronauts wear when they are working outside the space station.
3. How many items of clothing or equipment did you put on the person that is going outside to work?
4. Would it be exciting to work outside the space station? Why or why not?
5. Why do you think the astronauts usually wear slipper socks instead of heavy shoes?
6. While living aboard the space station, the astronauts will not bath and change clothes every day. How would you like to wear the same clothes for two days before you took a bath and got a new set? How would you feel about wearing the same clothing day and night for a whole week?
7. If you were an astronaut and you were sent to work on the space station, what kind of work would you like to do?

# Space Station Astronauts

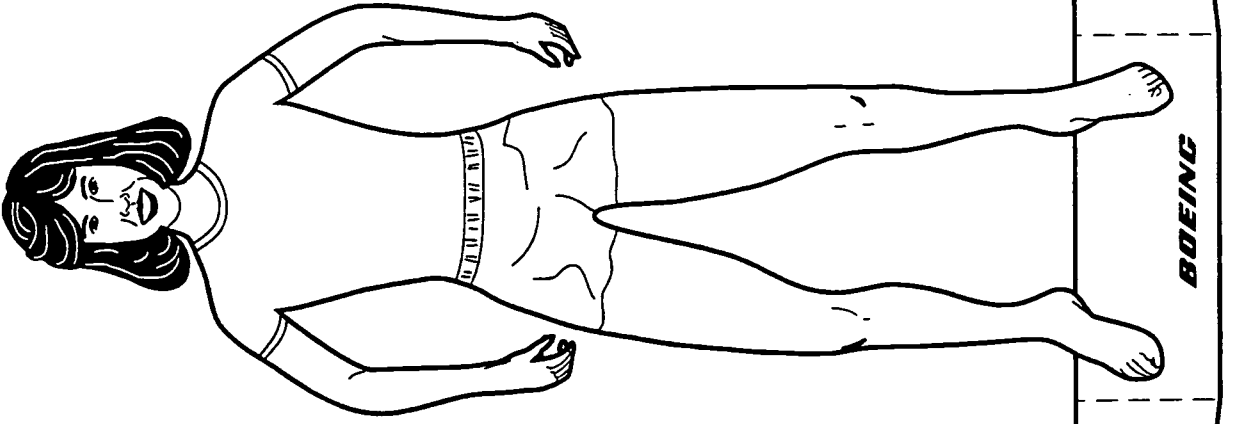
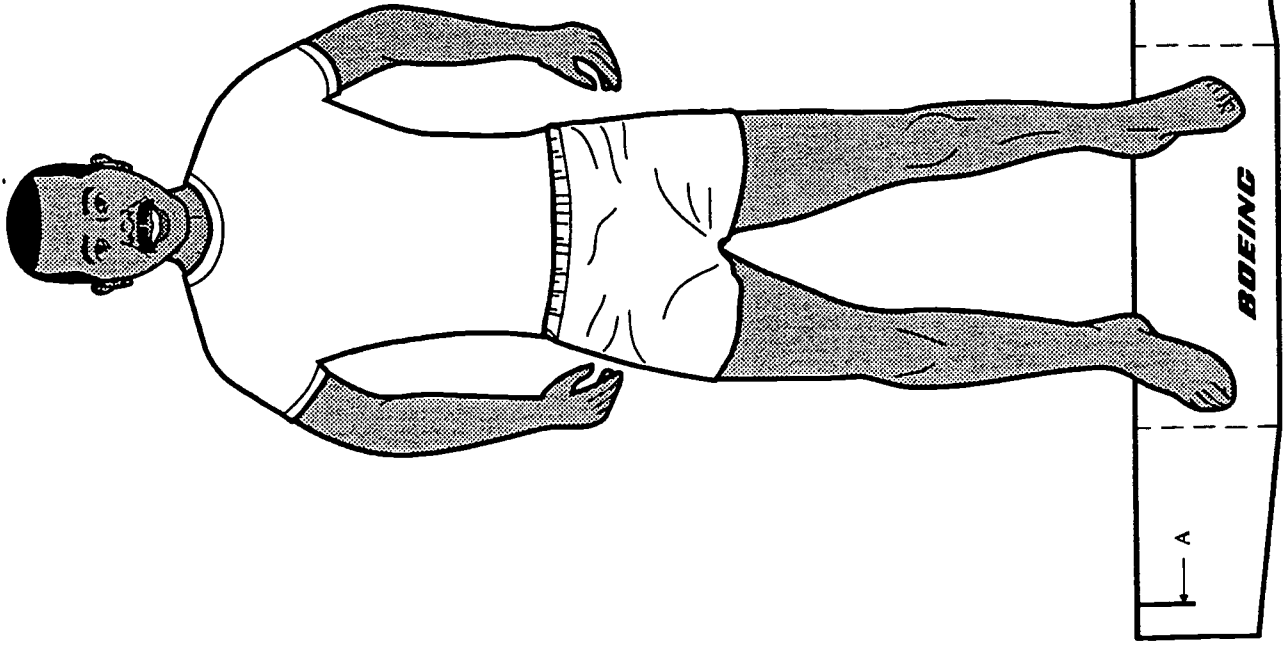

# Space Station Clothing

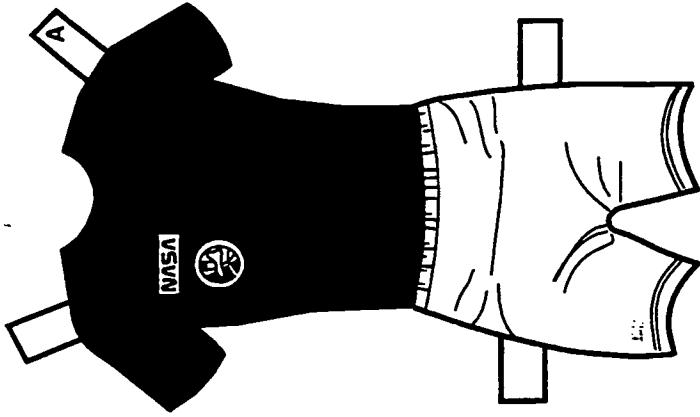

Shorts & Crew Shirt

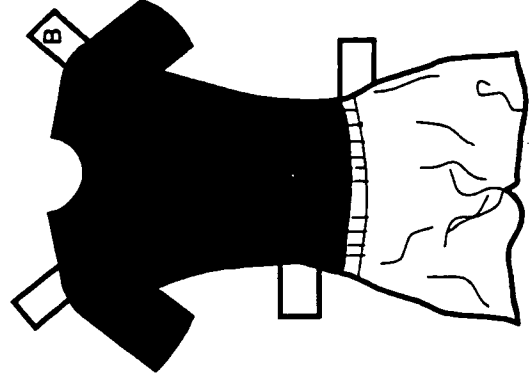

Sleeping Shorts & T Shirt

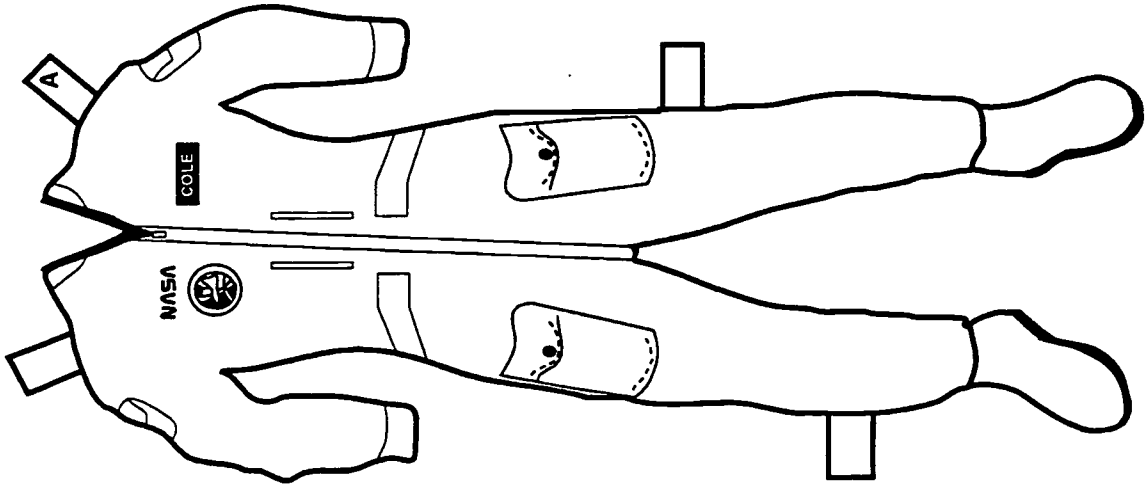

Flight Suit

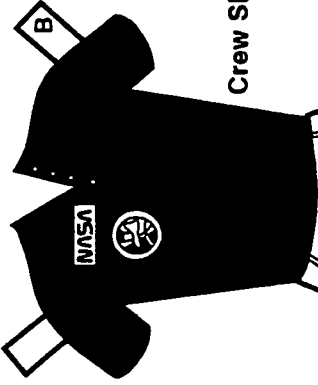

Crew Shirt

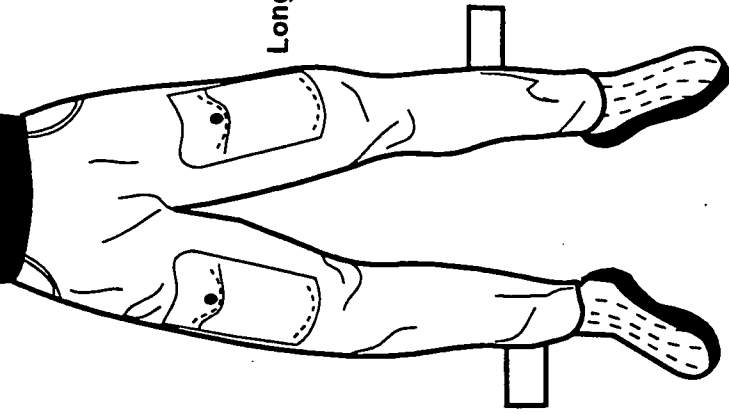

Long Pants

Sock Shoes

# Space Station Space Suit

## 1. COMMUNICATIONS CARRIER ASSEMBLY

Consists of microphone and headset. Allows astronaut to talk to the other crewmen in the orbiter or other space suit/life support systems.

## 2. INSUIT DRINK BAG

Stores liquid in the hard upper torso and has a tube projecting up into the helmet to permit the crew to drink while suited.

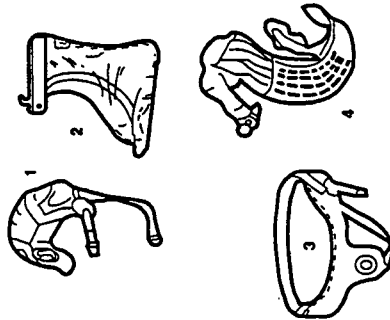

## 3. URINE COLLECTION DEVICE

Consists of the adapter tubing, storage bag and disconnect hardware for emptying liquid.

## 4. SERVICE AND COOLING UMBILICAL

Contains powers, recharge and communication lines, water and oxygen recharge lines and a water drain line. It has multiple connector at one end and a permanent fitting at the other.

## 5. DISPLAY AND CONTROL MODULE Chest

Mounted control module which contains all external fluid and electrical interfaces, controls and displays.

## 6. EMU ELECTRICAL HARNESS

Provides bio-instrumentation and communications connections to the portable life support system.

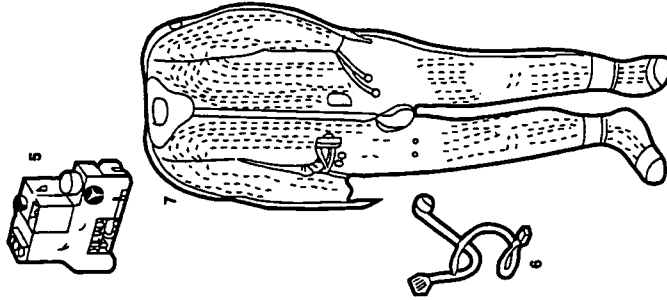

## 7. LIQUID COOLING AND VENTILATION GARMENT

Worn under the pressure garment. Consists of liquid cooling tubes that maintain desired body temperature.

## 8. EXTRAVEHICULAR VISOR ASSEMBLY

Attaches externally to the helmet. Contains visors which are manually adjusted to shield the astronaut's eyes.

9. HELMET Consists of a clear, polycarbonate bubble, neck disconnect and ventilation pad.

## 10. ARM ASSEMBLY

Contains the shoulder joint and upper arm bearings that permit shoulder mobility as well as the elbow joint and wrist bearing.

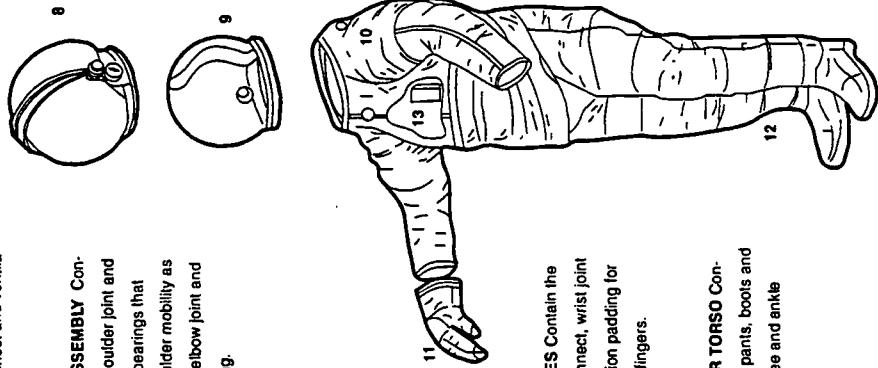

11. GLOVES Contain the wrist disconnect, wrist joint and insulation padding for palms and fingers.

12. LOWER TORSO Consists of the pants, boots and the hip, knee and ankle joints.

## 13. HARD UPPER TORSO

Provides the structural mounting interface for most of the EMU helmet, arms, lower torso, portable life support subsystem, displays and control module, and electrical harness.

14. CONTAMINANT CONTROL CARTRIDGE Consists of lithium hydroxide, charcoal and filters which remove carbon from the air the astronauts breathe. It can be replaced in flight.

15. BATTERY Provides all electrical power used by the space suit/life support system. It is stored dry and filled, sealed and charged prior to flight. The battery is rechargeable.

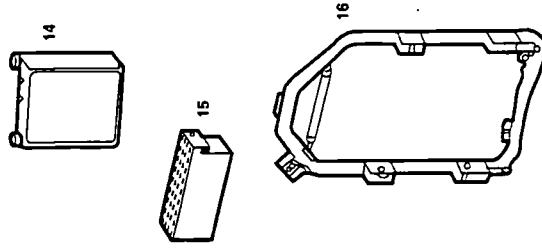

## 16. AIRLOCK ADAPTER PLATE

A mounting fixture during storage. It is used as an aid in donning and doffing the space suit/life support system.

## 17. PORTABLE LIFE SUPPORT SUBSYSTEM

Commonly referred to as the "backpack," this assembly contains the life support subsystem expendables (water and oxygen) and machinery.

## 18. SECONDARY OXYGEN PACK

Mounted to the base of the portable life support subsystem. It contains a 30-minute emergency oxygen supply and a valve and regulator assembly.

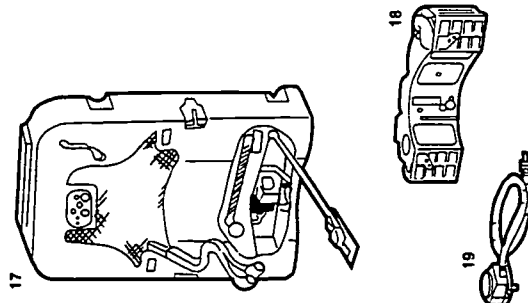

## 19. OXYGEN PURGE ADAPTER

A hose which connects the airlock and the suit. Flushes nitrogen out of the space suit just before the astronaut seals the helmet.

BEST COPY AVAILABLE

# Space Station Space Suit Liquid Cooling and Ventilation Garments

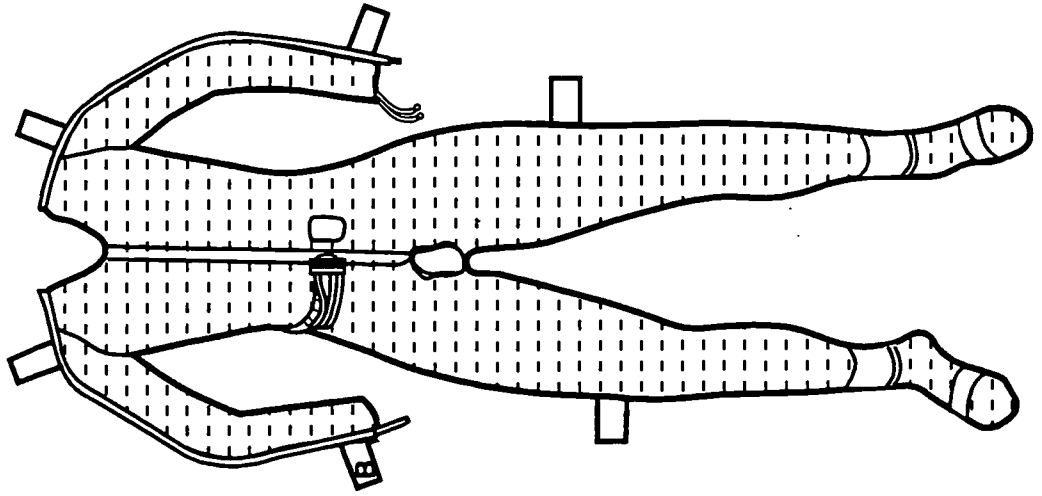
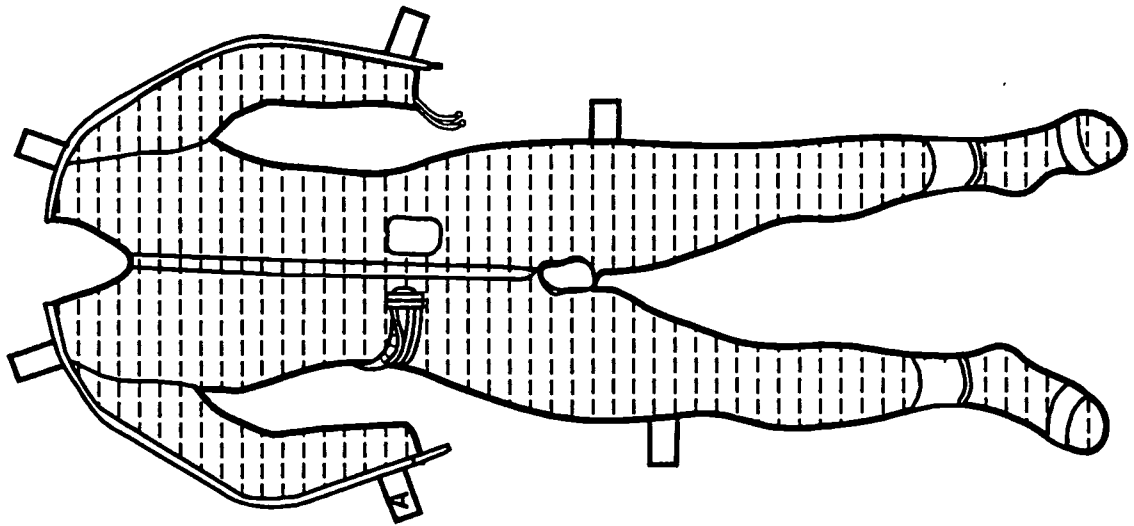

# Space Suits/ Extravehicular Mobility Units (EMU)

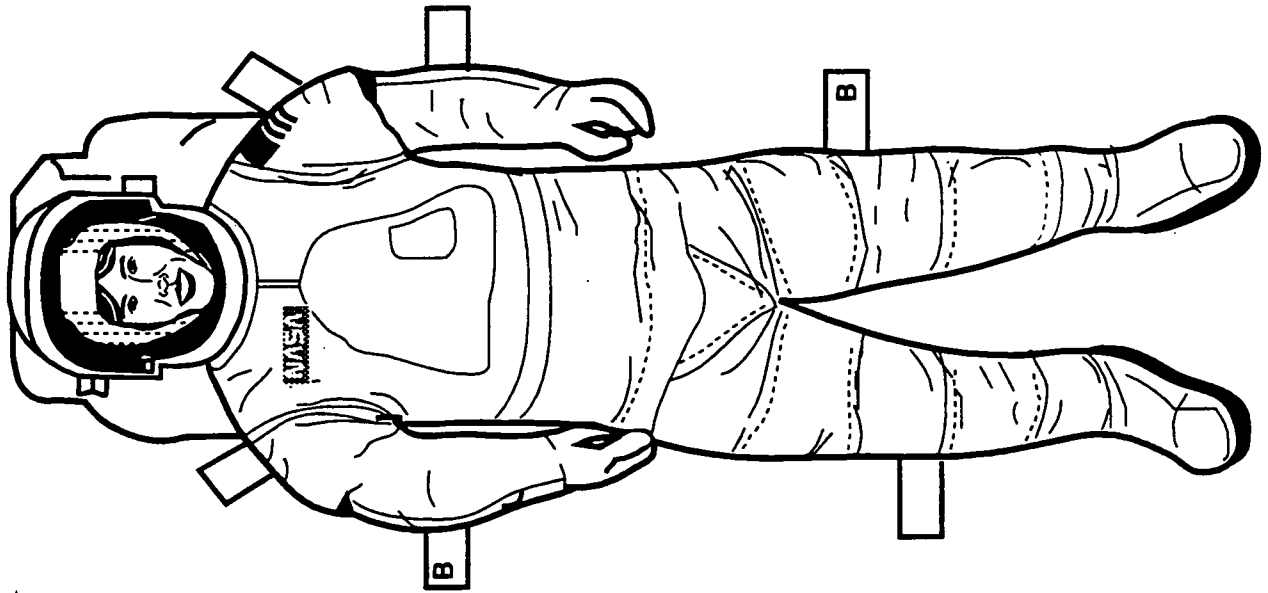
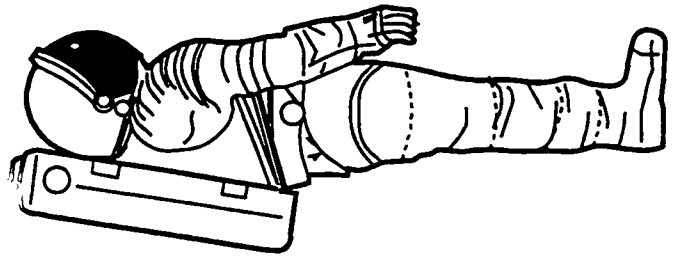
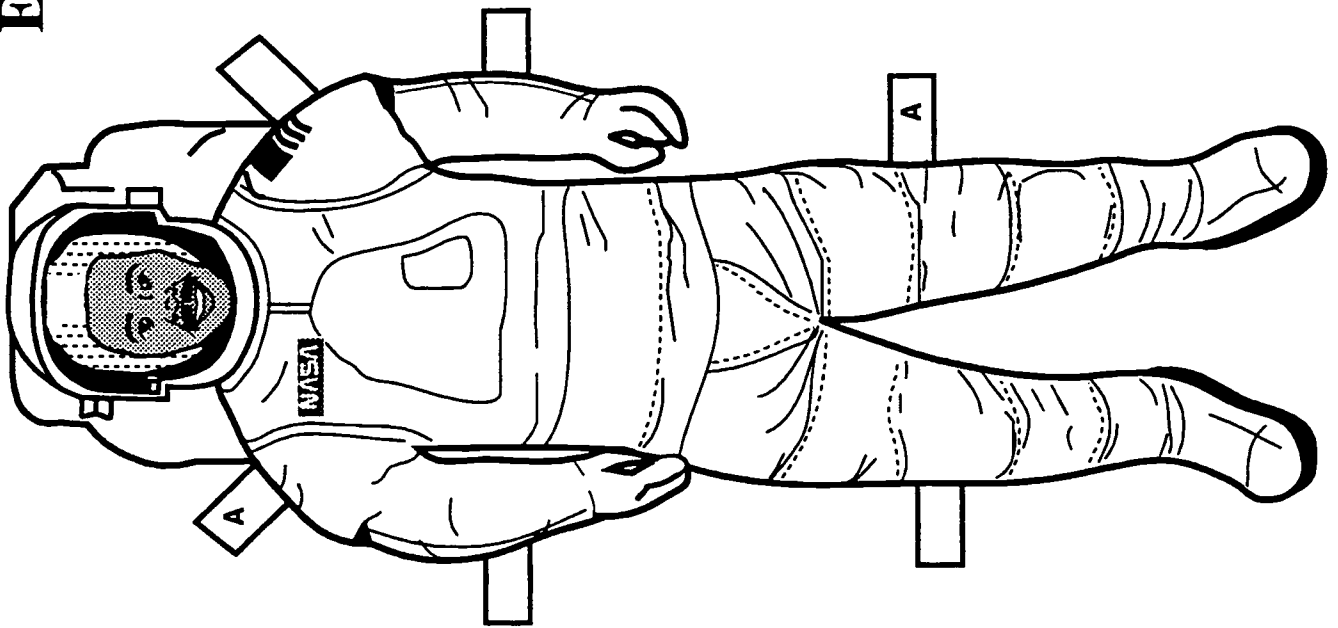



# Water Conservation on Space Station

Level (Grades K-5)

---

## THEORY/INFORMATION

Each crew member on the space station will be given about 23 liters or 6 gallons of water each day. This water is used for drinking, cooking, washing, and cleaning. All water on the space station will be carefully conserved. Even the waste water will be filtered, distilled, chemically treated, and reused. Scientists working with the Environmental Control and Life Support System (ECLSS) project at NASA are already able to make drinkable water from human waste.

## Objective

The student will measure his/her daily consumption of water and make a plan to use as little water as possible for drinking, cooking, bathing, and flushing the toilet.

## Questions

What is the smallest amount of water you can use in one day and stay healthy? What is the smallest amount of water that you can use to drink, cook, bathe, and flush the toilet?

## Materials

- 6 Clean, plastic gallon jugs
- 1 Cup measure
- 2 Water Conservation Record sheets (#1 & #2)
- 1 Water Conservation Plan for Day #2 sheet
- 1 Pencil

## Procedures

1. Measure the amount of water each time that you drink.
2. Record the amount of water you drink on the Water Conservation Record - Day #1 sheet.
3. Carefully measure the amount of water used to cook the food you eat. Record the amount each time your food is cooked.

# Procedures

4. Find out the size of the tank on your toilet at home. Record this amount each time you flush the toilet.
5. Estimate the amount of water you use in the shower. Record this amount each time you shower.
6. After you have collected all of this information, make a plan that will help you to use less water.
7. Write your plan on the sheet called "My Water Conservation Plan - Day #2." See the following instructions:
  - A. Fill the 6 clean, plastic, gallon jugs. Plan to use this water first. Hint: One gallon equals 16 cups.
  - B. Be sure to drink 8 glasses of water, because water is necessary to keep all the body systems healthy.
  - C. Plan to eat healthy food that needs very little water to prepare. If you choose to eat fresh fruit, remember the astronauts can only have it for the first two weeks on orbit because fruit spoils.
  - D. How can you shower, and still save water? What is your plan?
  - E. Can any water be reused?
  - F. Can you think of different ways of doing things so that you use less water?
8. On Day #2 use "Your Water Conservation Plan." Again measure all the water that you use. Be sure you get 8 glasses of water to drink.
9. Find the Water Conservation Record - Day #2 and record the amount of water used on Day #2.

# OBSERVATIONS, DATA AND CONCLUSIONS

1. How much water did you use on Day #1?
2. How much water did you use on Day #2?
3. What activities used the most water?
4. List as many ways to conserve water as possible.
5. Water has many uses, but when there is not enough water for everything you must decide which activities are most important to you. If you needed to save water on the space station, and you had to give up one activity, what would you give up? Why?
6. On Earth, each person needs to drink about 8 glasses of water each day. Why is it important to have enough water to drink during the 90-day Space Station Mission?
7. If you live on the space station, you will be given 6 gallons of water each day. Some of this water is sent up on each launch, and some of it will be made on orbit. How will more water be made usable?
8. When people stay on orbit for 90 days or more on the space station, they need to take foods that does not need much water to prepare. Describe some foods that you might take and tell why you chose them.
9. In this lesson water for drinking, cooking, bathing, and flushing the toilet was planned, but water is needed for other daily activities too. On orbit aboard the space station, what other activities might require water?
10. On Earth, some equipment like toilets, showers, and dish washers use a lot of water. What will these same machines need to be like if they are to be used in space?

# Water Conservation Record - Day #1

Date \_\_\_\_\_

Time \_\_\_\_\_

Amounts of Water Used in 24 Hours				
	Drink	Cook	Bathe	Toilet
1				
2				
3				
4				
5				
6				
7				
8				
9				
10				
<b>Totals</b>				

Day #1  
Total Amount \_\_\_\_\_

# My Water Conservation Plan

I, \_\_\_\_\_, will conserve water by using it wisely. I will plan the following activities so that I can use less water.

---

**Drinking Plan**

---

**Cooking Plan**

---

**Bath/Shower Plan**

---

**Toilet Flushing Plan**

---

**Space Station**

**BOEING 45**

# Water Conservation Record - Day #2

Date \_\_\_\_\_

Time \_\_\_\_\_

Amounts of Water Used in 24 Hours				
	Drink	Cook	Bathe	Toilet
1				
2				
3				
4				
5				
6				
7				
8				
9				
10				
<b>Totals</b>				

Day #2 Total Amount _____
------------------------------

# Space Station Math

Level (Grades 3-5)

## MATH (Calculator Optional)

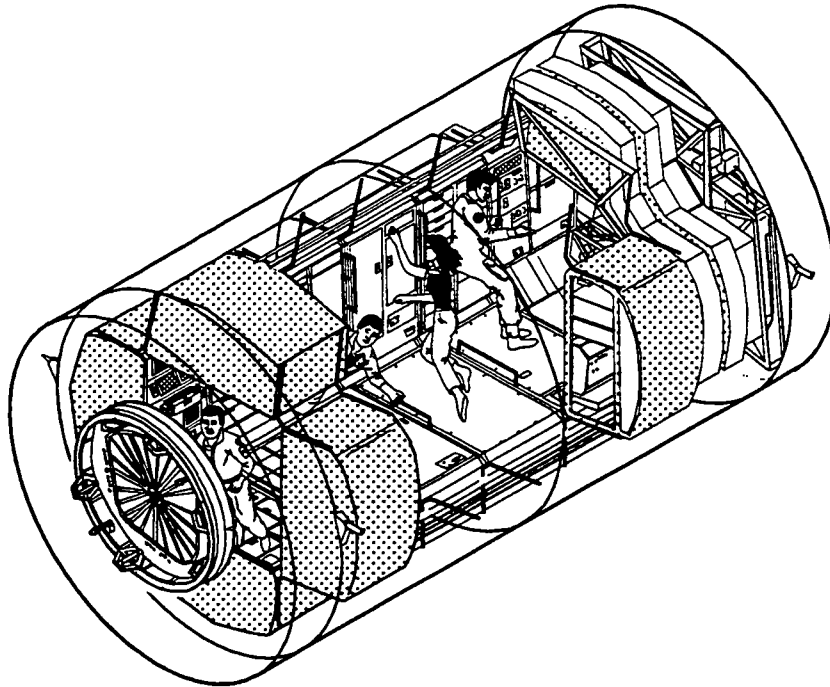

1. The space station is an international science and technology project shared by the United States, Japan, Canada and 9 European nations. The Russian Space Agency will also be part of the space station project. With the Russians participating, how many countries will work together on the space station?
2. The crew of the space station will be changed four times each year, and each crew will be on orbit for a 90-day shift. When the station is at permanent human capacity, there will be 6 crew members on the station. If each crew member serves only one shift, how many crew members will serve the first year? How many crew members will serve aboard the space station in 10 years?
3. Since all supplies have to be taken up to the space station, the crew is only allowed to use about 23 liters or 6 gallons of water each day. How many liters of water will one crew member use in 90 days? How many liters will six crew members use each 90 days?

4. The crew members are only allowed about 23 liters or 6 gallons of water each day for drinking, dish washing, laundry, and personal care. Pretend that you are an astronaut and you take a shower every seven days. If you are on orbit 90 days how many showers will you take?
5. Remember that each crew member is only allowed about 6 gallons of water each day. If a gallon of water weighs about 8.33 pounds, how much will the water for 90 days for one crew member weigh?
6. The space station will orbit the Earth. It will go completely around the Earth every 90 minutes. Half of this 90-minute orbit is in sunlight, and the other half is in the darkness of the Earth's shadow. In a 24-hour Earth day, how many times will the space station go around the Earth? How many periods of sunlight will the crew see? How many periods of darkness?
7. There are 24 hours in an Earth day, and each crew on the space station will spend 90 days on orbit. How many hours will each crew spend on the space station?
8. On orbit, the crew will have 8 hours each day for sleeping. How many hours will they sleep during the 90 day shift?
9. If the crew works works 12 hours each day, how many hours will the crew work in 90 days?
10. When they work on Earth, astronauts usually work 8 hours each day. On the space station, they will probably work 12 hours. How many more hours will they work each day on orbit?
11. On Earth, if people work more than 8 hours each day, they are usually paid more for working "overtime." If each astronaut works for 12 hours each day, how many hours of "overtime" will the crew of 6 astronauts work during each 90-day shift?
12. If a crew member sleeps 8 hours, exercises 2 hours, and works 12 hours, how many hours each day will be free to relax? How many hours will be free in each 90-day shift?
13. While on the space station, the astronauts must exercise at least two hours each day. They peddle an exercise bike, row a rowing machine, or run on a treadmill. How many hours do they exercise during the 90-day shift?



# Space Station

**BOEING**

## Answer Booklet

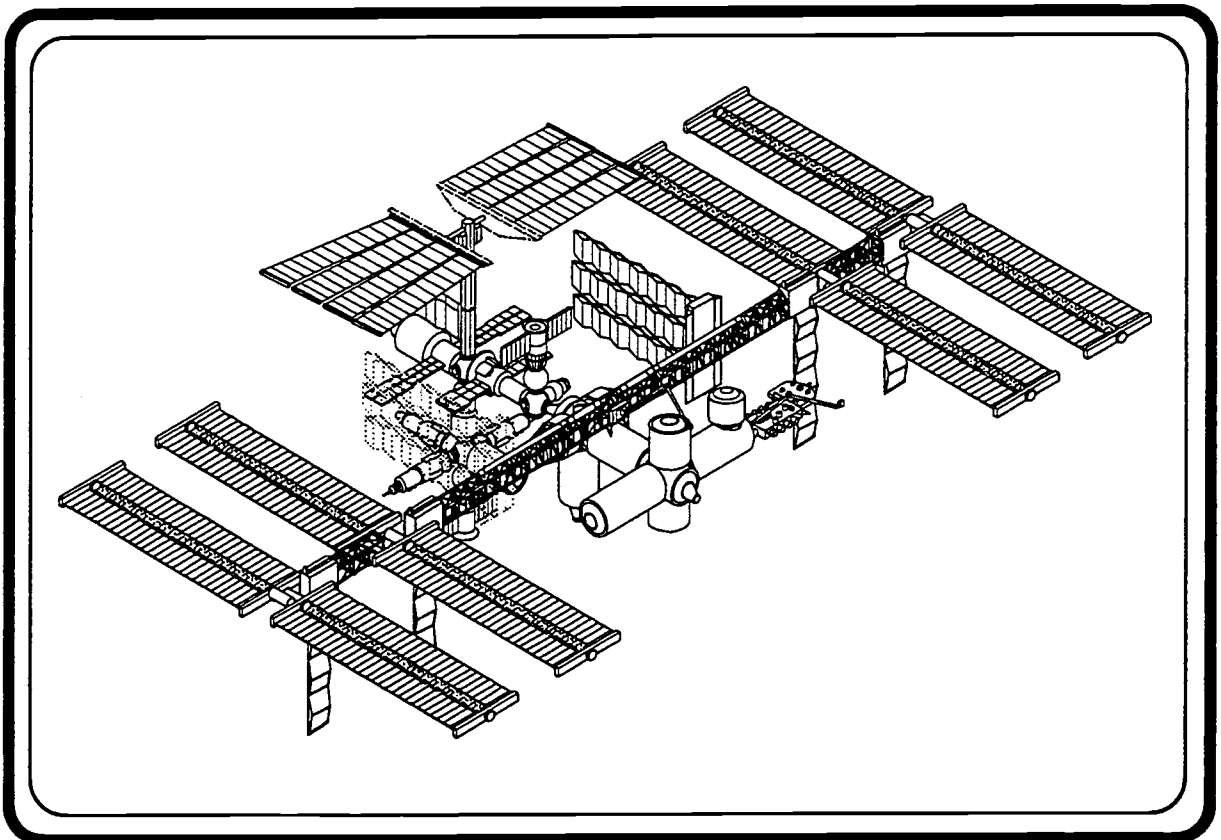

*The Boeing Company*

# Space Station Answer Booklet

Level (Grades K-5)

---

## Lesson 1: Space Station Identification

1. The **photovoltaic arrays** will make the electricity to run the space station. The photovoltaic arrays are made up of solar panels that collect the light from the Sun and use it to make electricity. The electricity will be used to power the space station and to power the machines and equipment used to do experiments, manufacture materials, and conduct studies.
2. The two parts of the space station used to hold all the parts of the station together are the truss and the nodes. The **truss** is a long backbone like structure on the outside of the station used to attach modules, nodes, and other equipment. The **nodes** are passageways that can be attached to at least four modules or other structures.
3. The astronauts will work in the **laboratory module**. They will study processes, manufacture materials, and do various experiments. Astronauts will also have to work outside the space station. They will help in the construction of the station, they will do normal maintenance work, and they may tend experiments that are attached to the outside of the station.
4. When the space station is permanently occupied by humans, the astronauts will live in the **habitat module**. They will cook, eat, clean, sleep, bathe, exercise, and relax. To maintain a healthy mind and body while involved in long duration space exploration, the astronauts must have a user friendly environment. They must have good foods, a clean environment, relaxation, and some degree of privacy.
5. The radiators remove heat from the Space Station. Heat generated inside the Space Station must be removed to keep the Space Station at a comfortable temperature for the astronauts to live in.
6. Answers will vary. Any answer is correct as long as the student has a reasonable explanation of his/her choice.

## Space Station Match Worksheet

1. Node - D
2. Habitat Module - C
3. Truss - B
4. Photovoltaic Array - A
5. Laboratory Module - E
6. Radiator - F

# Space Station Answer Booklet

Level (Grades K-5)

---

## Lesson 2: Space Station Habitat and Laboratory Modules

1. The outside of the habitat and laboratory modules are shaped like cylinders or long metal cans. The outside wall is called a bulkhead.
2. The inside of both the space station habitat and laboratory modules has four box-shaped flat surfaces. Two of the four surfaces are marked to look like walls with lights and air vents around the top. The racks located overhead and under foot are marked to look like the ceiling and floor of the two modules. More return air vents are located along the floor. Because the astronauts will spend long periods of time in space, scientists and engineers have tried to design the space station so that it is easy to live and work in the weightless environment.
3. There are 24 racks in the paper model of the habitat module. The real habitat module of the space station will have 24 racks, and the laboratory module will also have 24.
4. The galley is the eating area. It is located in the right half of the paper model.
5. The restroom and shower are two racks located side by side. These two racks are located on the wall opposite the galley and at the opposite end of the module. They are on the left half of the paper model.
6. If the furniture were placed in the space station, it would float unless it was attached to the floor.
7. While on orbit the astronauts can sleep almost anywhere because they are weightless and they float. Some astronauts have slept with their head down at the floor and their feet toward the lights. No matter how astronauts choose to sleep, they usually use some kind of sleeping restraint to keep them from bumping into the equipment or against a return air vent.
8. Answers will vary. The student might mention cooking, eating, bathing, taking photos, making movies, or relaxing.
9. (Optional) Any reasonable answer is acceptable.

# Space Station Answer Booklet

Level (Grades K-5)

---

## Lesson 3: Outfitted for Space Work

1. The astronaut working inside the laboratory module would probably wear a knit shirt, short or long pants, tennis shoes, safety goggles, and gloves.
2. The astronaut that works outside will wear an improved EMU (extravehicular mobility unit). The EMU is a very complicated space suit that protects the astronaut and keeps him/her comfortable and healthy. This space suit is made up of many layers. The EMU used in the space shuttle program has 12 layers, and the full suit consists of 19 different items. It takes the astronaut about 15 minutes to get dressed.
3. The real EMU includes 19 separate items. The drawing of the EMU has about 8 of these items.
4. Answers may vary.
5. The slipper socks worn by the astronauts are very comfortable and they keep the feet warm and clean. Heavy shoes are not needed, and the astronauts might damage the equipment if they push against it as they float around in the space station.
6. Answers may vary.
7. Answers may vary.

# Space Station Answer Booklet

Level (Grades K-5)

---

## Lesson 4: Water Conservation on Space Station

1. Answers will vary. Encourage the students to make accurate measurements and keep detailed records.
2. Answers will vary, but the amount of water used should be much less than the amount reported in Question 1.
3. Answers may vary. Flushing the toilet and bathing will probably use the most water.
4. Answers will vary.
5. Answers will vary. Depending on the age of the student, some students might like the idea of giving up the daily bath.
6. The astronauts must drink enough water everyday so that all their body systems stay healthy.
7. All water on the space station will be reused. All water including that recovered from respiration, perspiration, and urination is recovered, treated, and reused.
8. Answers will vary.
9. Answers will vary. Some activities that might require water include: brushing teeth, washing dishes, cleaning the space station, and experimenting.
10. All machines sent in to space must be designed to use very small amounts of water and energy.

# Space Station Answer Booklet

Level (Grades 3-5)

---

## Lesson 5: Space Station Math

1. Add, 13 countries.
2. Multiply,  $4 \times 6 = 24$  crew members each year,  $24 \times 10 = 240$  crew members in ten years.
3. Multiply,  $23 \times 90 = 2,070$  liters,  $2,070 \times 6 = 12,420$  liters.
4. Divide,  $90/7 = 12$  with 6 days more, 12 showers.
5. Multiply,  $8.33 \times 6 = 49.98$  pounds of water,  $49.98 \times 90 = 4,498.20$  pounds of water for ninety days.
6. Divide,  $24/1.5 = 16$  orbits each 24 hours. Every 90 minutes there is 45 minutes of darkness and 45 minutes of sunlight. In 24 hours there would be 16 periods of darkness and 16 periods of sunlight.
7. Multiply,  $24 \times 90 = 2,160$  hours.
8. Multiply,  $90 \times 8 = 720$  hours.
9. Multiply,  $12 \times 90 = 1,080$  hours.
10. Subtract,  $12 - 8 = 4$ .
11. Subtract, multiply,  $12 - 8 = 4$ ,  $90 \times 4 \times 6 = 2,160$  hours.
12. Add, subtract, multiply,  $12 + 8 + 2 = 22$ ,  $24 - 22 = 2$ ,  $90 \times 2 = 180$  hours.
13. Multiply,  $2 \times 90 = 180$  hours of exercise.

# NASA Teacher Resource Centers

---

NASA maintains collections of video tapes, laser video disks, slides and printed materials for use by educators. These collections, located in Teacher Resource Centers in each of the NASA Educational Service Regions, are available for perusal by educators. Each center features duplicating equipment for copying video tapes, audio cassette tapes, 35 millimeter slides, computer software, and lesson plans. In addition, NASA educational publications including curriculum guides, are available. Contact the Teacher Resource Center serving your state to arrange for educational material assistance.

<b>If you live in</b>	<b>Contact</b>
Alaska Arizona California Hawaii Idaho Montana Nevada Oregon Utah Washington Wyoming	NASA Ames Research Center Attn: Teacher Resource Center Mail Stop: TO-25 Moffett Field, CA 94035 415-694-6077
Connecticut Delaware District of Columbia Maine Maryland Massachusetts New Hampshire New Jersey New York Pennsylvania Rhode Island Vermont	NASA Goddard Space Flight Center Attn: Teacher Resource Laboratory Mail Stop: 130-3 Greenbelt, MD 20771 301-286-8570

# NASA Teacher Resource Centers

If you live in	Contact
Colorado Kansas Nebraska New Mexico North Dakota Oklahoma South Dakota Texas	NASA Johnson Space Center Attn: Teacher Resource Room Mail Stop: AP-1 Houston, TX 77058 713-483-8696
Florida Georgia Puerto Rico Virgin Islands	NASA Kennedy Space Center Attn: Educators Resource Laboratory Mail Stop: ERL Kennedy Space Center, FL 32899 305-867-4090 or 9383
Kentucky North Carolina South Carolina Virginia West Virginia	Virginia Air & Space Museum Attn: Teacher Resource Center 600 Setter's Landing Road Hampton, VA 23669 804-727-0800
Illinois Indiana Michigan Minnesota Ohio Wisconsin	NASA Lewis Research Center Attn: Teacher Resource Center Mail Stop: 8-1 2100 Brookpark Rd Cleveland, OH 44135 216-433-2017
Alabama Arkansas Iowa Louisiana Missouri Tennessee	U.S. Space and Rocket Center Attn: NASA Teacher Resource Center P.O. Box 070015 Huntsville, AL 35807-7015 205-544-5812
Mississippi	NASA John C. Stennis Space Center Attn: Teacher Resource Center Building 1200 Stennis Space Center, MS 39529 601-688-3338



# Acknowledgments

---

This publication was produced as a part of the continuing educational activities of The Boeing Company. The following deserve thanks for their assistance:

**Pat Armstrong**

Writer/Coordinator  
Teacher  
Huntsville City School System  
Huntsville, Alabama

**Harry E. Kindred, Sr.**

Technical Illustrator  
The Boeing Company  
Huntsville, Alabama

**Terry L. White**

Technical Illustrator  
The Boeing Company  
Huntsville, Alabama

**Contact:**

The Boeing Company  
Government & Community Affairs Department  
P.O. Box 240002  
MS JW-54  
Huntsville, Alabama 35824



**U.S. Department of Education**  
Office of Educational Research and Improvement (OERI)  
National Library of Education (NLE)  
Educational Resources Information Center (ERIC)

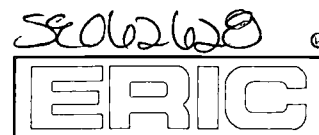

# REPRODUCTION RELEASE

(Specific Document)

## I. DOCUMENT IDENTIFICATION:

Title: <i>International Space Station: K-5 Hands-on Science</i>	
Author(s): <i>Pat Armstrong</i>	
Corporate Source: <i>Boeing</i>	Publication Date:

## II. REPRODUCTION RELEASE:

In order to disseminate as widely as possible timely and significant materials of interest to the educational community, documents announced in the monthly abstract journal of the ERIC system, *Resources in Education* (RIE), are usually made available to users in microfiche, reproduced paper copy, and electronic media, and sold through the ERIC Document Reproduction Service (EDRS). Credit is given to the source of each document, and, if reproduction release is granted, one of the following notices is affixed to the document.

If permission is granted to reproduce and disseminate the identified document, please CHECK ONE of the following three options and sign at the bottom of the page.

The sample sticker shown below will be affixed to all Level 1 documents

The sample sticker shown below will be affixed to all Level 2A documents

The sample sticker shown below will be affixed to all Level 2B documents

PERMISSION TO REPRODUCE AND DISSEMINATE THIS MATERIAL HAS BEEN GRANTED BY

*Sample*

---

TO THE EDUCATIONAL RESOURCES INFORMATION CENTER (ERIC)

PERMISSION TO REPRODUCE AND DISSEMINATE THIS MATERIAL IN MICROFICHE, AND IN ELECTRONIC MEDIA FOR ERIC COLLECTION SUBSCRIBERS ONLY, HAS BEEN GRANTED BY

*Sample*

---

TO THE EDUCATIONAL RESOURCES INFORMATION CENTER (ERIC)

PERMISSION TO REPRODUCE AND DISSEMINATE THIS MATERIAL IN MICROFICHE ONLY HAS BEEN GRANTED BY

*Sample*

---

TO THE EDUCATIONAL RESOURCES INFORMATION CENTER (ERIC)

Level 1

Level 2A

Level 2B

↑

↑

↑

Check here for Level 1 release, permitting reproduction and dissemination in microfiche or other ERIC archival media (e.g., electronic) and paper copy.

Check here for Level 2A release, permitting reproduction and dissemination in microfiche and in electronic media for ERIC archival collection subscribers only

Check here for Level 2B release, permitting reproduction and dissemination in microfiche only

Documents will be processed as indicated provided reproduction quality permits.  
If permission to reproduce is granted, but no box is checked, documents will be processed at Level 1.

*I hereby grant to the Educational Resources Information Center (ERIC) nonexclusive permission to reproduce and disseminate this document as indicated above. Reproduction from the ERIC microfiche or electronic media by persons other than ERIC employees and its system contractors requires permission from the copyright holder. Exception is made for non-profit reproduction by libraries and other service agencies to satisfy information needs of educators in response to discrete inquiries.*

Sign here, please →

Signature: <i>Lucy V. Slater</i>	Printed Name/Position/Title: <i>Lucy V. Slater, Mgr. Comm. Affairs</i>
Organization/Address: <i>Boeing P.O. 240002 Huntsville, AL 35824</i>	Telephone: <i>256-461-2278</i> FAX: <i>256-461-2252</i>
	E-Mail Address: Date: <i>7-22-99</i>

### III. DOCUMENT AVAILABILITY INFORMATION (FROM NON-ERIC SOURCE):

If permission to reproduce is not granted to ERIC, or, if you wish ERIC to cite the availability of the document from another source, please provide the following information regarding the availability of the document. (ERIC will not announce a document unless it is publicly available, and a dependable source can be specified. Contributors should also be aware that ERIC selection criteria are significantly more stringent for documents that cannot be made available through EDRS.)

Publisher/Distributor:
Address:
Price:

### IV. REFERRAL OF ERIC TO COPYRIGHT/REPRODUCTION RIGHTS HOLDER:

If the right to grant this reproduction release is held by someone other than the addressee, please provide the appropriate name and address:

Name:
Address:

### V. WHERE TO SEND THIS FORM:

Send this form to the following ERIC Clearinghouse:

ERIC/CSMEE  
1929 Kenny Road  
Columbus, OH 43210-1080

However, if solicited by the ERIC Facility, or if making an unsolicited contribution to ERIC, return this form (and the document being contributed) to:

**ERIC Processing and Reference Facility**  
1100 West Street, 2<sup>nd</sup> Floor  
Laurel, Maryland 20707-3598

Telephone: 301-497-4080

Toll Free: 800-799-3742

FAX: 301-953-0263

e-mail: [ericfac@inet.ed.gov](mailto:ericfac@inet.ed.gov)

WWW: <http://ericfac.piccard.csc.com>

